

ECAC-CR-83-200 cy. 23

AD-A155204

DEPARTMENT OF DEFENSE
Electromagnetic Compatibility Analysis Center
Annapolis, Maryland 21402

FIELD ANTENNA HANDBOOK

Prepared for
Joint Chiefs of Staff

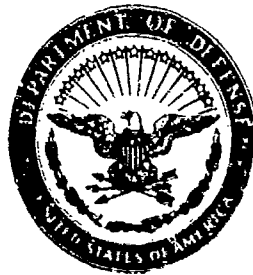

JUNE 1984

CONSULTING REPORT

Prepared by
James A. Kuch

MIT Research Institute
Under Contract to
Department of Defense

Approved for public release; distribution unlimited.

ECAC LIBRARY

Annapolis, Maryland

You are personally accountable for this
book. DO NOT transfer this book to another
person without permission of the library.

85 11 14 08

ECAC-CR-83-200

This report was prepared by the IIT Research Institute as part of AF Project 649E under Contract F-19628-80-C-0042 with the Electronic Systems Division of the Air Force Systems Command in support of the DoD Electromagnetic Compatibility Analysis Center, Annapolis, Maryland.

This report has been reviewed and cleared for open publication and/or public release by the appropriate Office of Information (OI) in accordance with AFR 190-17 and DoDD 5230.9. There is no objection to unlimited distribution of this report to the public at large, or by DTIC to the National Technical Information Service (NTIS).

8/28/2822

Reviewed by

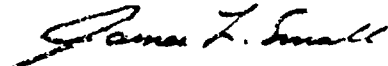
JAMES L. SMALL
Project Manager, IITRI

JOHN V. JONES
Director of Research
Contractor Operations

Approved by

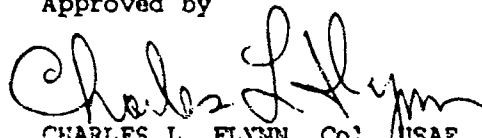
CHARLES L. FLYNN, Col, USAF
Director

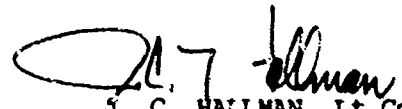
J. C. HALLMAN, Lt Col, USMC
Marine Corps Deputy Director

812756

UNCLASSIFIED

SECURITY CLASSIFICATION OF THIS PAGE (When Data Entered)

REPORT DOCUMENTATION PAGE		READ INSTRUCTIONS BEFORE COMPLETING FORM
1. REPORT NUMBER ECAC-CR-83-200	2. GOVT ACCESSION NO.	3. RECIPIENT'S CATALOG NUMBER
4. TITLE (and Subtitle) FIELD ANTENNA HANDBOOK		5. TYPE OF REPORT & PERIOD COVERED CONSULTING
		6. PERFORMING ORG. REPORT NUMBER
7. AUTHOR(s) James A. Kuch		8. CONTRACT OR GRANT NUMBER(s) F-19628-80-C-0042 CDRL # 10P
9. PERFORMING ORGANIZATION NAME & ADDRESS DoD Electromagnetic Compatibility Analysis Center North Severn Annapolis, MD 21402		10. PROGRAM ELEMENT, PROJECT, TASK AREA & WORK UNIT NUMBERS P0553
11. CONTROLLING OFFICE NAME AND ADDRESS Joint Chiefs of Staff		12. REPORT DATE JUNE 1984
		13. NUMBER OF PAGES 98
14. MONITORING AGENCY NAME & ADDRESS (if different from Controlling Office)		15. SECURITY CLASS. (of this report) UNCLASSIFIED
		15a. DECLASSIFICATION/DOWNGRADING SCHEDULE
16. DISTRIBUTION STATEMENT (of this Report) Approved for public release; distribution unlimited.		
17. DISTRIBUTION STATEMENT (of the abstract entered in Block 20, if different from Report)		
18. SUPPLEMENTARY NOTES		
19. KEY WORDS (Continue on reverse side if necessary and identify by block number) ANTENNAS HIGH FREQUENCY PROPAGATION VERY HIGH FREQUENCY		
20. ABSTRACT (Continue on reverse side if necessary and identify by block number) This handbook presents basic propagation theory, the fundamentals concerning antennas, and the design and use of tactical high frequency and very high frequency antennas. It is a field reference for basic antenna facts and a usage guide for antennas.		

UNCLASSIFIED

SECURITY CLASSIFICATION OF THIS PAGE (When Data Entered)

TABLE OF CONTENTS

<u>Title</u>	<u>Page</u>
INTRODUCTION.....	1
SECTION I HF AND VHF PROPAGATION FUNDAMENTALS	
HIGH FREQUENCY COMMUNICATIONS (2 TO 30 MHz).....	3
Ground-Wave Propagation.....	3
Sky-Wave Propagation.....	4
VERY HIGH FREQUENCY COMMUNICATIONS (30 TO 88 MHz).....	8
SECTION II ANTENNA FUNDAMENTALS	
WAVELENGTH AND FREQUENCY.....	11
RESONANCE.....	12
POLARIZATION.....	13
REFLECTIONS.....	13
GAIN.....	15
TAKE-OFF ANGLE.....	15
PATTERNS.....	16
SECTION III HF ANTENNAS	
GENERAL.....	21
DETERMINING ANTENNA GAIN.....	24
ANTENNA SELECTION PROCEDURE.....	25
Selection Procedures.....	25
Example.....	25
AS-2259/AS-2268.....	27

TABLE OF CONTENTS (Continued)
SECTION III (Continued)

<u>Title</u>	<u>Page</u>
OE-85/OE-86.....	29
VERTICAL WHIP.....	31
HALF-WAVE DIPOLE.....	35
INVERTED VEE.....	41
LONG WIRE.....	43
INVERTED L.....	46
SLOPING VEE.....	49
SLOPING WIRE.....	52
VERTICAL HALF RHOMBIC.....	57

SECTION IV
VHF ANTENNAS

GENERAL.....	61
VERTICAL WHIP.....	65
RC-292.....	66
OE-254.....	68
AS-2236.....	70
AS-2851.....	72
VERTICAL HALF RHOMBIC/OE-303.....	75

SECTION V
EXPEDIENT TECHNIQUES

REPAIR OF BROKEN ANTENNAS.....	79
INSULATORS.....	80
SUPPORTS.....	80
TERMINATING RESISTORS.....	81

TABLE OF CONTENTS (Continued)
SECTION V (Continued)

<u>Title</u>	<u>Page</u>
EXPEDIENT WIRE.....	82
GROUNDING.....	83
SECTION VI	
FOR MORE INFORMATION.....	85

INTRODUCTION

Of all the variables affecting communications, the one factor that the individual operator has the most control over is the antenna and its use. By using the proper antenna, an operator may change a marginal circuit into a reliable circuit. This handbook presents basic propagation theory, the fundamentals of antennas, and the design and use of tactical high frequency and very high frequency antennas. A working knowledge of this handbook will allow the operator to properly select and employ individual antennas to provide the strongest possible signal at the receiving station of his circuit. This handbook is not intended to be a technical handbook on antennas, but is intended to be a field reference for basic antenna facts and a usage guide for antennas.

Sections I and II present information which should be understood by radio operators, however, this handbook can be used without thorough knowledge of those sections. Section III contains HF antenna selection procedures and describes the more common tactical HF antennas. Section IV does the same for VHF antennas. Section V presents information on making antennas using field available materials. Section VI lists publications available from the different services that give detailed information on propagation and antennas.

SECTION I HF AND VHF PROPAGATION FUNDAMENTALS

Propagation is the process by which a radio signal travels through the atmosphere from one antenna to another. This section briefly describes the propagation factors that need to be known to better understand the antenna information presented in the following sections. This section is divided into two major parts, high frequency (HF) propagation and very high frequency (VHF) propagation. Each part can stand alone so that the radio operator interested in only HF or VHF communications can go directly to that part.

HIGH FREQUENCY COMMUNICATIONS (2 TO 30 MHz)

High frequency communications is accomplished by either ground-wave or sky-wave propagation. With current low-powered man-pack radios, ground-wave communications can be established out to 20 to 30 kilometers (km). High powered equipment (mounted in jeeps and vans) can extend that range to approximately 80 to 100 km. The coverage from sky-wave communications, on the other hand, can vary from several kilometers to thousands of kilometers.

Ground-Wave Propagation

Ground-wave propagation involves the transmission of a radio signal along or near the surface of the earth. The ground-wave signal is divided into three parts: the direct wave, the reflected wave, and the surface wave.

The direct wave travels through the atmosphere from one antenna to the other in what is called the line-of-sight (LOS) mode. Maximum LOS distance is dependent on the height of an antenna above the ground; the higher the antenna the further the maximum LOS distance. Because the radio signal travels in air, any obstructions, such as a mountain, between the two antennas can block or reduce the signal and prevent communications. For an antenna 10 feet above the earth, a maximum LOS distance of about 6.5 to 8 km (4 to 5 miles) can be expected.

The reflected wave, like the direct wave, travels through the atmosphere but reflects off the earth in going from the transmitting antenna to the receiving antenna. Together, the reflected wave and the direct wave are called the space wave.

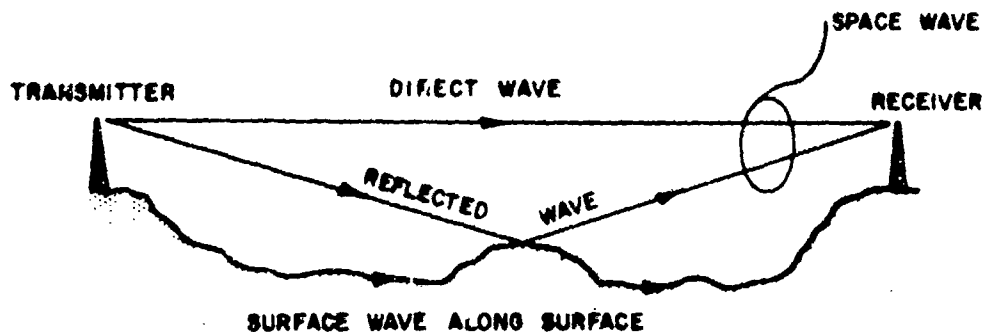

Components of ground wave.

The third part of a ground wave is the surface wave. This part travels along the surface of the earth and is the usual means of ground-wave communication. The surface wave is very dependent on the type of surface between the two antennas. With a good conducting surface, such as sea water, long ground-wave distances are possible. If there is a poor surface between the antennas, such as sand or frozen ground, the distance expected for the surface wave is small. The surface wave range can also be reduced by heavy vegetation or mountainous terrain.

Sky-Wave Propagation

Beyond the range covered by the ground-wave signal, HF communications are possible through sky-wave propagation. Sky-wave propagation is possible because of the bending of the radio signal by a region of the atmosphere called the ionosphere.

The ionosphere is an electrically charged (ionized) region of the atmosphere that extends from about 60 km (37 miles) to 1000 km (620 miles) above the earth's surface. The ionization results from energy from the sun and causes radio signals to return to earth. Although the ionosphere exists up to 1000 km, the area important for HF communications is below about 500 km. This area is divided up into four regions: D, E, F1, and F2.

The D region is closest to earth and only exists during the daylight hours. It does not have the capability to bend a radio signal back to earth but it does play an important role in HF communications. The D region absorbs energy from the radio signal passing through it thereby reducing the strength of received signals.

The E region, the next higher region, is present 24 hours a day, although during night hours it is much weaker than during the day. The E region is the first region with enough charge to bend radio signals. At times, parts of the E region become highly charged and can either help or block out HF communications. These highly charged areas are called Sporadic E and occur most often during the summer.

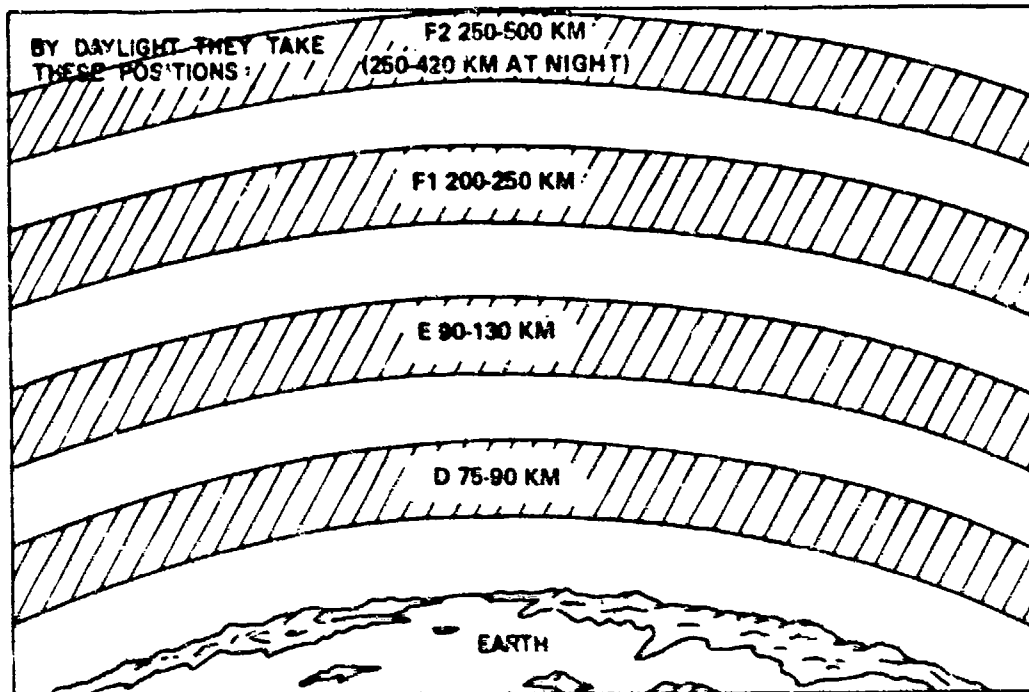

Structure of the ionosphere.

The most important regions for HF communications are the F1 and F2 regions. The majority of HF skywave communications depend on these regions with the F2 region being used the most for long range daytime communications.

The bending of a radio signal by the ionosphere depends on the frequency of the radio signal, the degree of ionization in the ionosphere, and the angle at which the radio signal strikes the ionosphere. At a vertical (straight up) angle, the highest frequency that will be bent back to earth is called the critical frequency. Each region of the ionosphere (E, F1, F2) will have a separate critical frequency. For a vertical angle, signals above the highest critical frequency will pass through all ionospheric regions and on into outer space. Frequencies below the critical frequency of a region will be bent back to the earth by that region; however, if the frequency is too low, the signal will be absorbed by the D region. In order to have HF sky-wave

communications, a radio signal must be a high enough frequency to pass through the D region but not too high a frequency so that it does not pass through the reflecting region.

The angle at which a radio signal strikes the ionosphere plays an important part in sky-wave communications. As mentioned above, any frequency above the critical frequency will pass through the reflecting region. If the radio signal having a frequency above the critical frequency was launched at an angle, instead of straight up, the signal could be bent back to earth instead of passing through the region. This can be compared to skipping stones across a pond. If the stone was thrown straight down at the water it would penetrate the surface. But if the angle at which the stone is thrown is lowered, an angle will be reached where, instead of going into the water, the stone will skip across the pond. For every circuit there is an optimum angle above the horizon, called take-off angle, that will produce the strongest signal at the receiving station. This optimum take-off angle is used to select the appropriate antenna for a specific circuit.

Although a radio signal is actually bent by the ionosphere, the term reflection is commonly used to describe the turning back of a radio signal by the ionosphere. Reflection will be used in this handbook, even though bending is what actually occurs.

Because many antennas radiate energy at several angles, more than one wave from the transmitter may reach the receiver. An example is shown in the illustration.

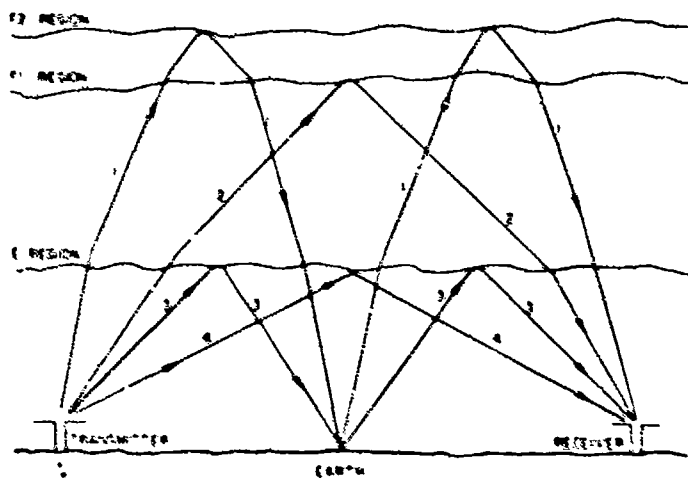

Multiple transmission paths.

Two important things are shown in this illustration. First, radio signals arrive at the receiver after being reflected from different ionospheric regions; and second, the path may consist of one or more reflections (hops) from the ionosphere. Any path that consists of two hops or more also involves a reflection at the ground somewhere between the stations.

Path 1 is at an angle such that the wave is partially bent by both the E and the F1 regions but is reflected by the F2 region. It is reflected by the earth and again by the F2 region before reaching the receiver. This path is referred to as a two-hop F (2F) path.

Path 2, at a smaller angle, is bent by the E region, then reflected by the F1 region. It is thus a one-hop F (1F) path.

Path 3 is at an angle small enough for E region reflection. It is reflected from the ground and again by the E region before reaching the receiver and thus is called a two-hop E (2E) path.

Path 4 is reflected by the E region only once, hence it is a one-hop E (1E) path.

Depending on the type of antennas used, signals can be received from any or all of the different paths. Because each path covers a different distance, the signals arrive at the receiver at different times. When two or more signals arrive at the receiver from different paths, they can interfere with each other and cause what is called multipath interference. This type of interference will produce echoes or motor boating on circuits even though a receiver's S-meter shows a strong received signal.

Depending on the frequency, antennas, and other factors, an area may exist between the longest ground-wave range and shortest sky-wave range where no signal exists. This is called the skip zone.

HF propagation involves much more than what has been presented here. For example, multiple frequencies are usually needed to maintain sky-wave communications. As a minimum, two frequencies, one for daytime and one for nighttime are normally required. Numerous books and field manuals exist for those who want to learn more. The references section of this handbook

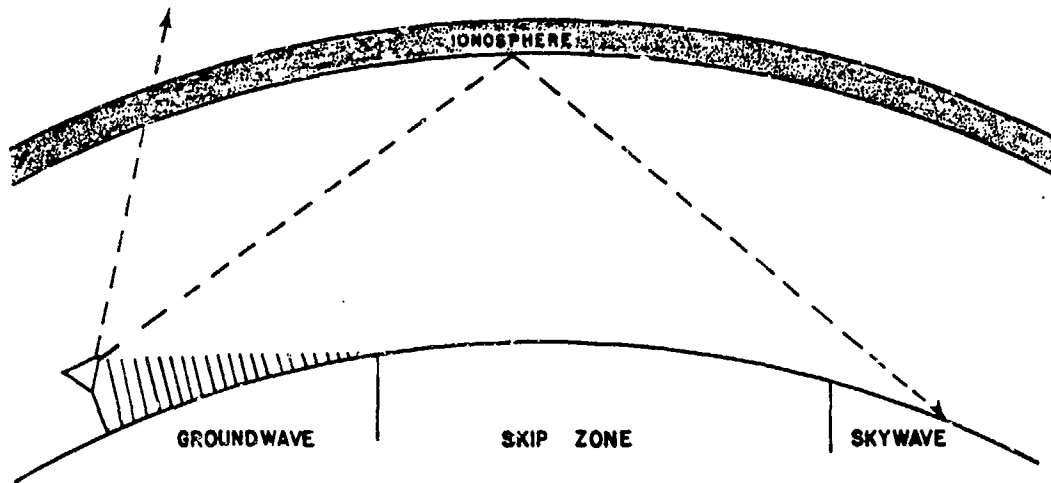

Illustration of an HF skip zone.

lists some that should be readily accessible to the individual operator.

VERY HIGH FREQUENCY COMMUNICATIONS (30 TO 88 MHz)

VHF communications are possible through what is called VHF line of sight (VHF-LOS) propagation. VHF-LOS propagation is influenced by four separate components that result in the received signal: the direct ray, the reflected ray, the refracted ray, and the diffracted ray.

The direct ray travels the straight line distance from the transmitting antenna to the receiving antenna. Because of the curvature of the earth, the maximum distance between two antennas for a direct ray is determined by the height of the antennas above the earth. The higher the antennas, the longer the effective range.

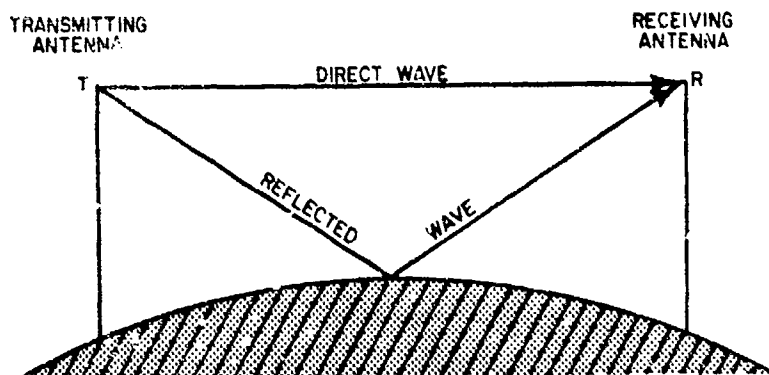

Transmission of direct and reflected waves.

The reflected ray, like the direct ray, travels through the atmosphere but reflects off the earth's surface in going from one antenna to the other. The reflected ray may cause a troublesome type of interference. The path traveled by the reflected ray is longer than that of the direct ray, therefore the reflected ray arrives at the receiving antenna after the direct ray. If the two rays are "in phase", they will reinforce each other producing a stronger signal. If they arrive "out of phase", one signal will cancel the other resulting in very poor or nonexistent communications. It is this cancelling effect that explains why, at times, no signal is received even though the transmitting antenna is in sight. Moving the antennas either closer or further from each other, or changing the height of one of the antennas should result in a usable signal.

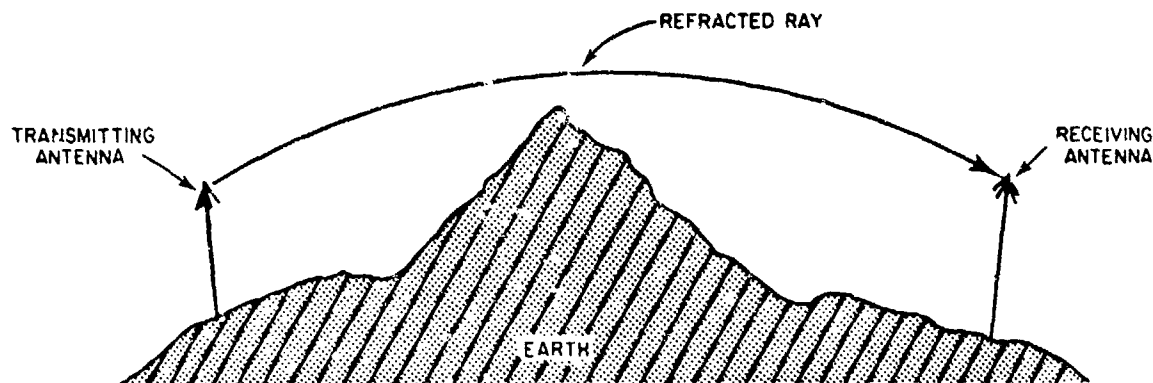

VHF refraction.

The refracted ray is what allows the line-of-sight distance for a radio signal to be greater than visual line of sight. The differences in the lower atmosphere cause the transmitted signal to bend slightly back to earth. This bending permits the refracted ray to travel further than the direct ray. The VHF-LOS distance resulting from the refracted ray is shown in the graph. This graph indicates the distance that VHF-LOS exists for a transmitting antenna on the ground and a receiving antenna at the height indicated. The height of the receiving antenna goes up to 1000 feet to allow the determination of VHF-LOS distance to an aircraft.

The diffracted ray scatters around obstacles and permits communications in the shadow region behind obstacles. Low frequencies scatter (diffract) more than higher frequencies, so it is not uncommon for a lower-frequency signal to diffract across a hill top and result in reliable communications at a receiver antenna located not far below the line of sight, while at the same time a signal of higher frequency will not be heard.

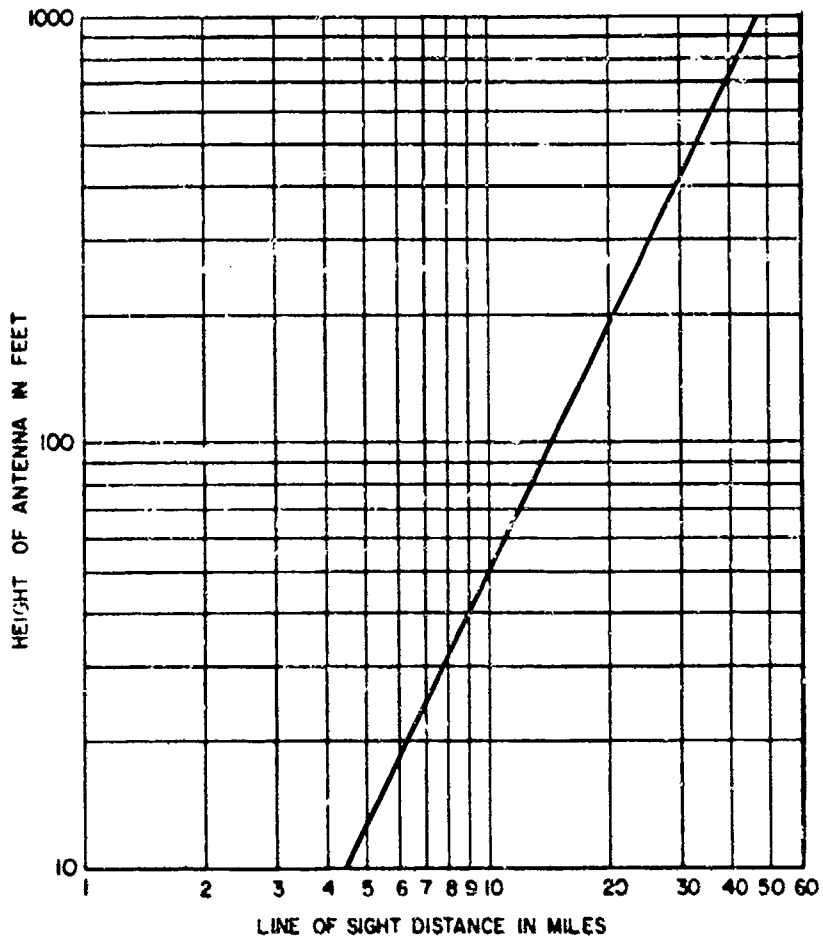

Line of sight distance in miles.

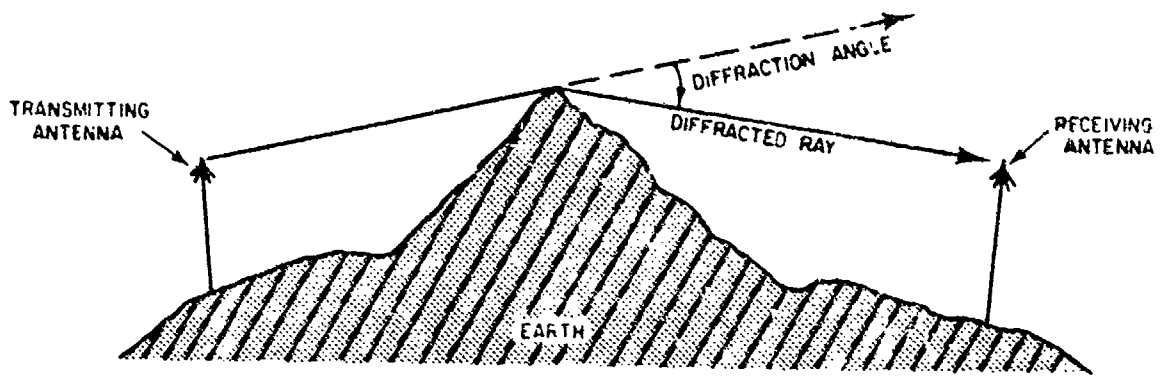

VHF diffraction.

SECTION II

ANTENNA FUNDAMENTALS

To be able to properly select antennas for a radio circuit, certain antenna concepts need to be understood. This section defines several basic terms and relationships which will help the field radio operator select the best antenna for his circuit.

WAVELENGTH AND FREQUENCY

In radio frequency communications, there is a definite relationship between antenna length and transmitter frequency wavelength. This relationship is important when constructing antennas for a specific frequency or frequency range. The wavelength of a radio signal is the distance traveled in the time it takes to complete one cycle.

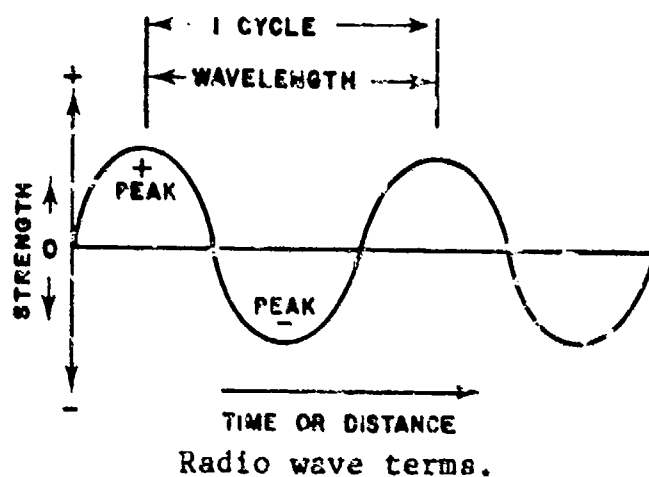

Wavelength is usually represented by the Greek letter, λ , pronounced lambda. All radio signals travel at the speed of light. The wavelength of a frequency is equal to the speed of light divided by the frequency. To find the wavelength of 3 MHz:

$$\text{Wavelength } (\lambda) = \frac{300,000,000 \text{ m/s}}{3,000,000 \text{ Hz}} = 100 \text{ meters or } 328 \text{ feet}$$

This means that in the time it takes to complete one cycle at 3 MHz, the signal travels 100 meters or 328 feet. This is the distance the signal will travel through air; the distance in a wire is slightly less and will be discussed in a later section.

RESONANCE

Antennas can be classified as either resonant or non-resonant depending on their design. In a resonant antenna, almost all of the radio signal fed to the antenna is radiated. If the antenna is fed with a frequency other than the one for which it is resonant, much of the fed signal will be lost and will not be radiated. A resonant antenna will effectively radiate a radio signal for frequencies close to its design frequency, usually only 2% above or below the design frequency. In practice this means that if a resonant antenna is used for a radio circuit, a separate antenna must be built for each frequency to be used on the radio circuit. A non-resonant antenna, on the other hand, will effectively radiate a broad range of frequencies with lower efficiency. Both resonant and non-resonant antennas are commonly used on tactical circuits.

If a resonant antenna is fed with a frequency outside of its bandwidth (usually plus or minus 2% of the design frequency) large losses of signal power occur. Signal energy from the antenna feedline is "turned back" from the antenna and causes standing waves on the feedline. A measure of these standing waves, called standing wave ratio (SWR), is used to determine if an antenna is resonant at a particular frequency. A SWR of 1 to 1 (1:1) is the ideal situation but in the real world 1.1 to 1 is about the best that can be done. When constructing wire antennas, the length of the antenna should be adjusted until the lowest SWR is measured. A SWR of 2:1 is acceptable; however, the operator's manual for the particular radio in use should be checked to determine the maximum SWR that the radio can tolerate. In some radios, the power output of the transmitter will be automatically lowered if the SWR is too high.

Suppose the situation exists where the only antenna that can be erected is one with a large SWR, that is too large for the transmitter to work. In this situation, a coupler or "antenna tuner" must be used. A coupler is a device that is inserted between a transmitter and its antenna to make a transmitter think that it is connected to a low SWR antenna. The advantage is that the transmitter can deliver its full power to the feed line even though the SWR is high. The amount of power radiated by the antenna depends on the location of the coupler. If the coupler is located at the transmitter, as it is with most tactical equipment, a large loss of power will still exist at the antenna. If the coupler is located at the antenna, a greater amount of power is radiated with less loss.

POLARIZATION

Polarization is the relationship of the radio energy radiated by an antenna to the earth. The most common polarizations are horizontal (parallel to the earth's surface) and vertical (perpendicular to the earth's surface), however others, such as circular and elliptical, also exist. A vertical antenna normally radiates a vertically polarized signal and a horizontal antenna normally radiates a horizontal signal. In HF ground-wave and VHF-LOS propagation, both the transmit and receive antennas should have the same polarization for best communications. In the case of HF ground-wave propagation, vertical polarization should be used. Either vertical or horizontal polarization can be used in VHF-LOS. For HF sky-wave propagation, the polarization of the transmitting and receiving antennas does not have to be the same because of the random changing of the signal as it is bent by the ionosphere. This random changing allows the use of either vertical or horizontal polarization at the transmitting or receiving antenna.

REFLECTIONS

A quarter-wave vertical antenna requires a good ground connection in order to be resonant. When a quarter-wave vertical antenna has its base on the ground, the earth below the antenna acts like a large reflector (or mirror) and supplies another quarter wavelength. In effect, the quarter-wave vertical acts like a half-wave antenna.

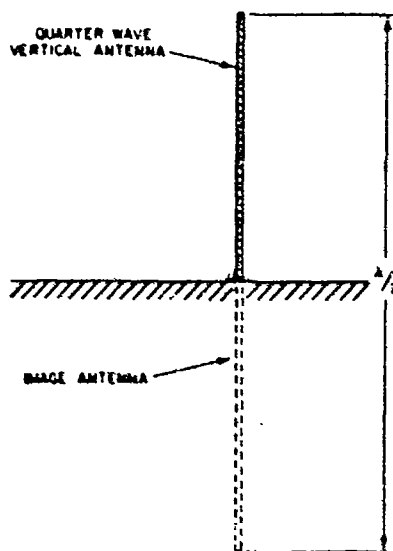

Ground reflection of a quarter-wave vertical antenna.

If the electrical characteristics below the antenna are poor, there will be large losses in the ground resulting in poor radiation by the antenna. It is important to remember that a quarter-wave vertical antenna needs a good ground below it to work properly.

Ground screens and ground planes are used with vertical antennas to improve their efficiency. (Efficiency of an antenna is a measure of how well an antenna radiates the radio energy delivered to it.) A ground screen consists of radial wires roughly a quarter-wavelength long.

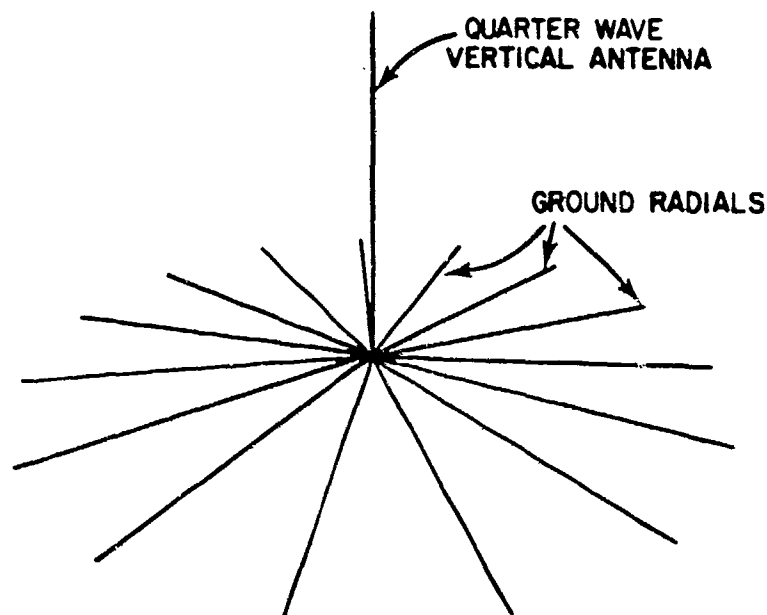

Quarter-wave vertical antenna with ground radials.

In HF communications, the ground screen is placed on the ground with the center of the screen directly under the antenna. This configuration would cause problems in VHF communications where the antenna should be as high as possible to obtain maximum VHF-LOS range. The short length of a quarter-wavelength at VHF (2.5 meters to 1 meter) allows the use of tubing to form a ground-plane antenna. The lower elements of this antenna provide the ground required for the quarter-wave vertical antenna to work properly. With its artificial ground, the ground-plane antenna can be placed at any height and still function properly. The tactical ground-plane antennas (RC-292, OE-245) have their ground-plane elements dropped down at an angle. This dropping of the ground plane causes the antenna to radiate its radio signal at a low take-off angle best for VHF-LOS propagation.

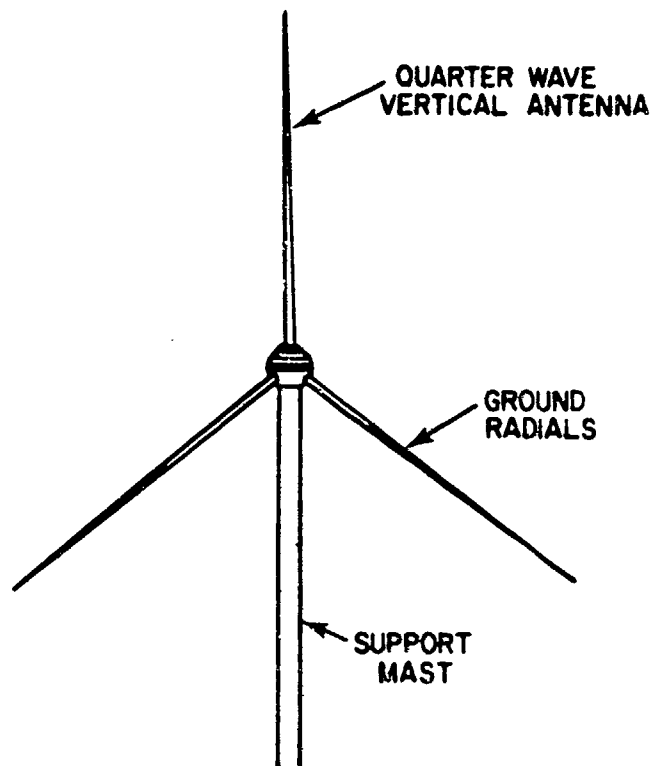

Ground-plane antenna.

GAIN

Gain is the term used to describe how well an antenna radiates power. It is necessary to know what the gain of an antenna is being compared to before two antennas can be compared. In some cases, an antenna is said to have gain compared to an isotropic antenna and the gain is expressed in dBi. An isotropic antenna is a theoretical mathematical antenna. Other times, gain is referenced to a horizontal half-wave dipole in free space whose gain over an isotropic antenna is 2.14 dBi. To determine the isotropic gain of an antenna whose gain is given compared to a dipole, add 2.14 dB. For example, if an antenna has a given gain of 2 dB compared to a dipole, its gain compared to an isotropic antenna is 4.14 dBi. In this handbook, gains are always referenced to an isotropic antenna.

TAKE-OFF ANGLE

The take-off angle of an antenna is the angle above the horizon that an antenna radiates the largest amount of energy. For VHF communications, antennas are designed so that the energy is radiated parallel to the earth (do not confuse take-off angle and polarization!). In HF communications, the take-off angle of

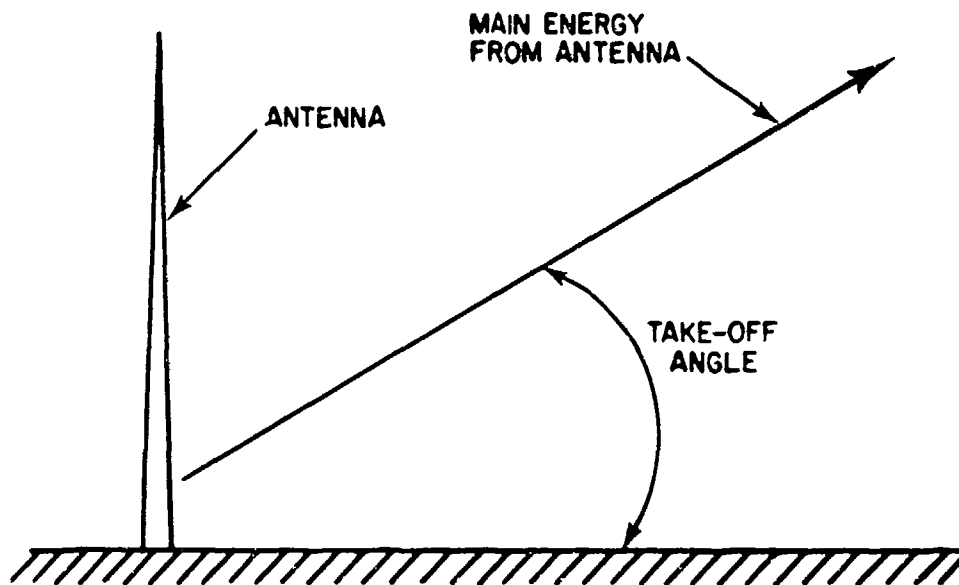

Antenna take-off angle.

an antenna can determine whether a circuit is successful or not. HF sky-wave antennas are designed for specific take-off angles depending on the circuit distance. High take-off angles are used for short range communications and low take-off angles are used for long range communications.

PATTERNS

Antenna patterns graphically show the radiation pattern for a specific antenna. The solid pattern in the lower left of the illustration is a representation of the radiation from a half-wave dipole antenna in free space (free space means there is nothing near the antenna that can change or distort the pattern). As can be seen, the solid pattern labeled 1 is shaped like a donut. If the donut is sliced in half on the horizontal axis, the half donut labeled 2 would result. Plotting the half donut on a polar graph results in the horizontal, or azimuthal pattern, 3. This is the same as looking straight down at the radiation pattern. In this case the antenna radiates radio energy equally in all directions. If the donut is sliced in half vertically, the half donut labeled 4 results. Plotting this gives the vertical pattern 5. This is the representation of the vertical pattern of the antenna. The vertical pattern is labeled with the terms lobe and null. A lobe is an area indicating the general direction of radiation from an antenna. A null is an area of no radiation. In practical tactical antennas, there is always a little radiation in all directions, so the term null is used to indicate the areas of minimum radiation.

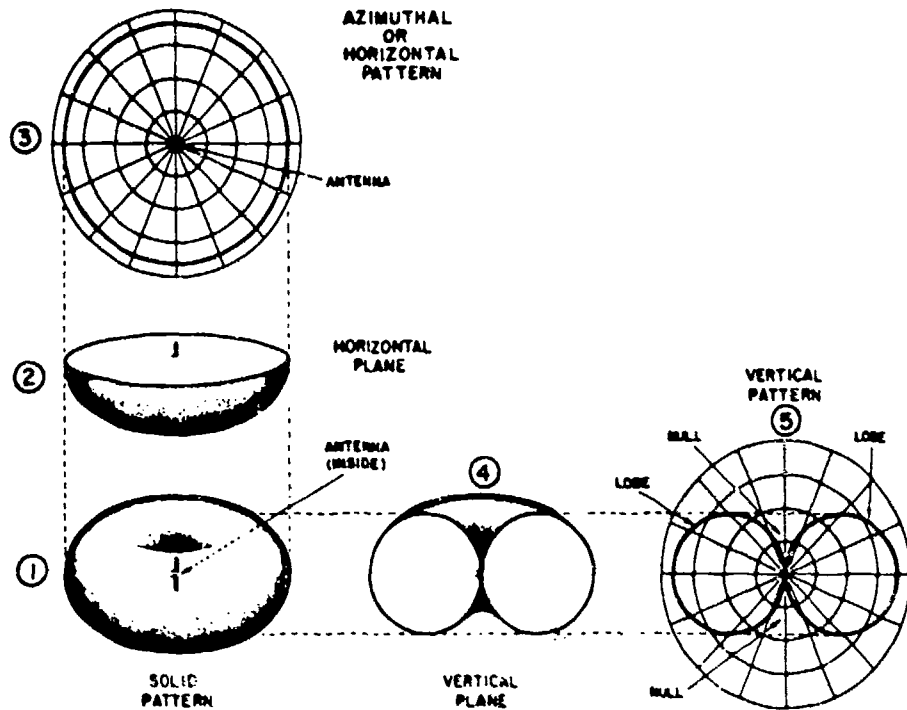

Vertical and horizontal polar plots.

Antennas are classified according to how radio energy is radiated: omnidirectional, bidirectional, or directional. An omnidirectional antenna radiates radio energy in a circular pattern, that is, all directions on the ground receive an equal amount of radiation. A bidirectional antenna has two main lobes opposite each other with nulls between. A directional antenna has a single large lobe in one direction. Each of these antennas will be discussed separately.

The most common omnidirectional antenna is the whip, with others being the quarter-wave vertical (RC-292, OE-254) and the crossed dipole (AS-2259). Radiating energy equally well in all compass directions, the omnidirectional antenna is used when it is necessary to communicate in several separated directions at once. Since the omnidirectional antenna radiates equally well in all directions, it will also receive from all directions. For a multiple point circuit this is desirable, however, it also allows interference from any direction to the received signal.

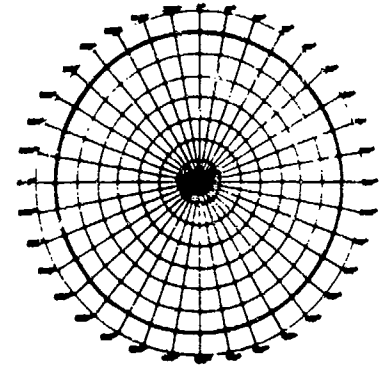
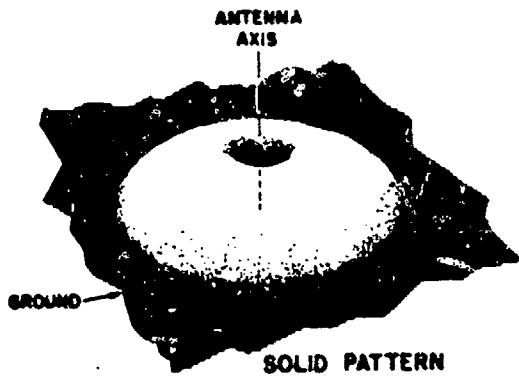

Omnidirectional antenna pattern.

Bidirectional antennas produce a stronger signal in two favored directions while reducing the signal in other directions. Tactical bidirectional antennas are usually field expedients like sloping wires, random length wires, and half-wave dipoles. Bidirectional antennas are usually used on point-to-point circuits and in situations where the antenna nulls can be positioned to reduce or block out interfering signals when receiving. They can also be used when many antennas are closely located. By placing other antennas in the nulls of bidirectional antennas, interference and interaction between the antennas can be reduced. A drawback of bidirectional antennas is that they have to be oriented correctly to radiate in the desired directions.

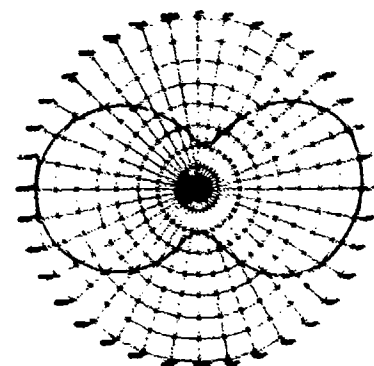
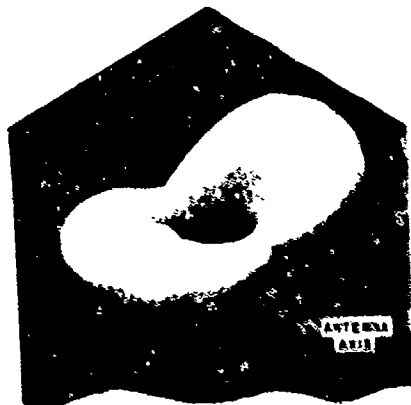

Bidirectional antenna pattern.

A directional antenna is much like a bidirectional antenna with one of its lobes cut off. In fact, several bidirectional antennas (long wire, sloping Vee) are made directional by the addition of a termination that absorbs the second main lobe. A termination is a resistor that matches the antenna and is capable of absorbing one-half the power output of the connected transmitter.

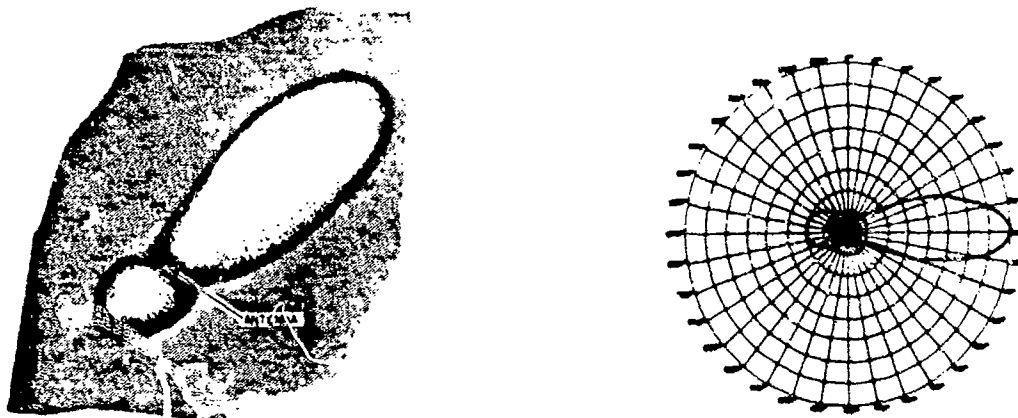

Directional antenna pattern.

A directional antenna concentrates almost all the radio signal in one specific direction, therefore, it must be carefully oriented. Depending on the antenna design, the main lobe of a directional antenna can cover 60° or more, or be a narrow pencil beam. Directional antennas are usually used on long-range point-to-point circuits where the concentrated radio energy is needed for circuit reliability.

It is important to realize that the azimuthal pattern of an antenna does not determine the take-off angle of the antenna. Depending on design, an omnidirectional antenna may have a low take-off angle or a high take-off angle. Vertical patterns must be examined to determine the take-off angles of particular antennas in the HF range. VHF antennas can be selected using only the azimuthal pattern because these antennas are all designed to be used for VHF-LOS propagation.

SECTION III HF ANTENNAS

GENERAL

How important is the antenna in a radio circuit? Suppose an AN/TSC-15 with its component 32-foot whip was set up on a 200-mile circuit. With the radiation characteristics of the whip antenna, the radiated power of the transmitter/whip could be 300 watts for the take-off angle required for a 200-mile circuit. If a half-wave horizontal dipole at a height of 35 feet were used instead of the whip, the radiated power would be 5000 watts. By using the dipole instead of the whip, the radiated power was increased more than 16 times. Obviously a circuit with 5000 watts radiated power will produce a better signal than a 300-watt circuit using the same frequency.

In selecting an antenna for a HF circuit, the first thing to be looked at is the type of propagation. Ground-wave propagation requires low take-off angle and vertically polarized antennas. The whip antenna that comes with all radio sets provides good omnidirectional ground-wave radiation. If a directional antenna is needed, select a directional antenna with good low angle vertical radiation.

Sky-wave propagation makes the selection of an antenna more complex. The first step is to find the distance of the circuit so that the required take-off angle can be determined. The take-off angle vs. distance tables gives approximate take-off angles for daytime and nighttime sky-wave propagation. Suppose the circuit distance is 966 km/600 miles. During daytime, the required take-off angle would be approximately 25° while at night it would be 40°. Therefore, an antenna that has high gain from 25° to 40° should be selected for the circuit. If propagation predictions are available, this step can be skipped since the predictions will probably give the take-off angles required.

The next decision is what type of coverage is required. If the radio circuit consists of mobile (vehicular) stations or many stations at different directions from the transmitter, an omnidirectional antenna is required. If the circuit is point to point, either a bidirectional or directional antenna can be used. Normally the receiving station locations dictate this choice.

Before a definite antenna can be selected, the materials available for antenna construction need to be examined. If a

TAKE-OFF ANGLE VS. DISTANCE

Take-Off Angle (Degrees)	Distance			
	F ₂ Region Day Time		F ₂ Region Night Time	
	km	mi	km	mi
0	3220	2000	4508	2800
5	2415	1500	3703	2300
10	1932	1200	2898	1800
15	1450	900	2254	1400
20	1127	700	1771	1100
25	965	600	1610	1000
30	725	450	1328	825
35	644	400	1127	700
40	564	350	966	600
45	443	275	805	500
50	403	250	685	425
60	258	160	443	275
70	153	95	290	180
80	80	50	145	90
90	0	0	0	0

horizontal dipole is to be erected, at least two supports are needed (a third support in the middle is required for frequencies of 5 MHz or less). If these supports are not available and there are no other items that can be used as supports, the dipole cannot be put up and another antenna should be selected. The physical site of the antenna should be looked at to determine if the proposed antenna will fit. If the site is too small, a different antenna needs to be selected.

Another consideration is the site itself. More times than not, the tactical situation determines the position of the communications antennas. The ideal setting would be a clear flat area with no trees, buildings, fences, power lines, or mountains. Unfortunately, such an ideal location is seldom available for the tactical communicator. In picking an antenna site, choose an area as flat and as clear as possible. If obstructions are around the proposed site, try to maintain the horizontal distance as listed in the below table. Again, this is for the ideal case and in many situations an antenna must be put up in far less than ideal sites. This does not mean that the antenna will not work, but that the site will affect the pattern and functioning of the antenna.

Antenna Take Off Angle	Required Horizontal Distance from Trees ^a	
0°	18	km
5°	1932	meters
10°	966	
15°	644	
20°	483	
25°	370	
30°	298	
35°	241	
40°	201	
45°	169	
50°	145	
60°	105	
70°	64	
80°	32	
90°	0	

^aAssuming a 30-foot high antenna and 75-foot high trees.

Once the antenna has been selected, a way to feed the power from the radio to the antenna has to be selected. Most tactical antennas are fed with coaxial cable (RG-213). Coax is a reasonable compromise between efficiency, convenience, and durability. Issued antennas come complete with the necessary connections to connect directly to a radio or to coaxial cable which connects to a radio. Problems may arise in connecting

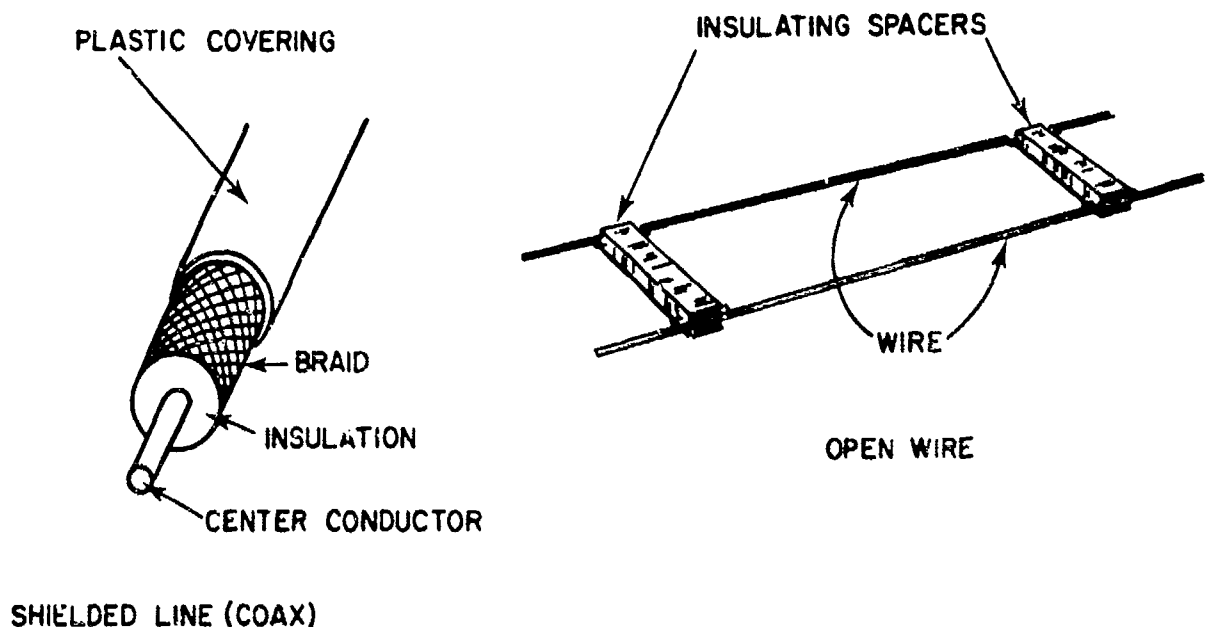

Antenna feed lines.

field expedient antennas. The horizontal half-wave dipole should be fed with balanced transmission line (open-wire). Coaxial cable can be used but may cause unwanted RF currents on the coaxial cable. To prevent the unwanted RF current flow, which can cause a radio to be "hot" and shock an operator, a device called a balun is used. The balun is installed at the dipole feed point (center) and prevents unwanted RF current flow on the coaxial cable. If a balun is not available, the coaxial cable used to feed the antenna can be used as a choke to prevent unwanted RF current flow. The center wire of the cable is connected to one leg of the dipole with the cable braid connected to the other antenna leg. The coaxial cable is then formed into a 6-inch coil consisting of ten turns of cable and is taped to the antenna under the insulator for support.

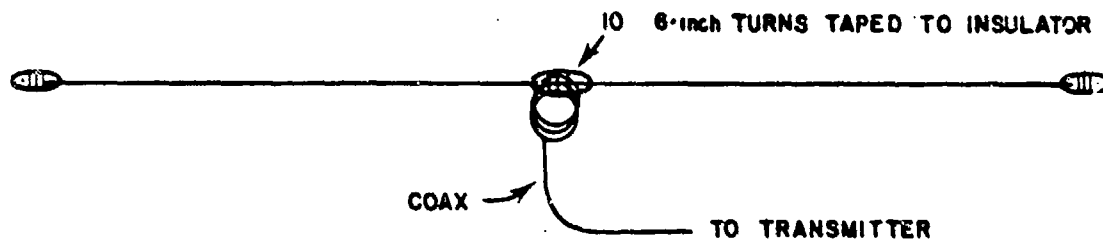

Coax RF current choke.

Baluns are also used to change the impedance of coaxial cable to match an antenna. RG-213 cable has a characteristic impedance of 52 ohms. If it were connected directly to an antenna that has an impedance of 600 ohms, large losses would exist. A balun changes the impedance of the cable to match the antenna which allows all the radio energy to pass into the antenna.

DETERMINING ANTENNA GAIN

The gain of an antenna at a specific take-off angle can be determined from its vertical radiation pattern. Look at the vertical antenna pattern for the 32-foot vertical whip (bottom page 33). The numbers along the outer ring (90°, 80°, 70°, etc.) represent the angle above the earth; 90° would be straight up and 0° would be along the ground. Along the bottom of the pattern are numbers from -10 (at the center) to +15 (at the edges). These numbers represent the gain in dBi. Each pattern shows the gain of an antenna for three frequencies (normally 3, 9, and 18 MHz). To find the gain of an antenna at a particular frequency and take-off angle, locate the desired take-off angle on the plot. Follow that line towards the center of the plot until the

pattern of the desired frequency is reached. Drop down and read the gain from the bottom scale. For example, if the gain of a 32-foot vertical whip at 9 MHz and 20° take-off angle were desired, first locate 20° along the outer scale. Follow this line until the 9-MHz pattern (dashed line) is reached. Moving down to the bottom scale, the gain would be a little less than 2 1/2 dBi (the line between 0 and 5 dBi). In this case the gain of a 32-foot vertical whip at 9 MHz and 20° would be 2 dBi.

Once the overall characteristics of an antenna are determined, the antenna selection matrix can be used to find the specific antenna for a circuit. Suppose the proposed circuit required a short range omnidirectional wide-band antenna. From the selection matrix, the only antenna that meets all the criteria is the AS-2259.

ANTENNA SELECTION PROCEDURE

Selection Procedures

HF sky-wave antenna selection is comprised of the following steps:

- Determine the range
- Determine type of coverage: omnidirectional, bidirectional, or directional
- Determine materials available for antenna construction
- Use HF Antenna Selection Matrix to find antennas that meet the above requirements
- Look up individual antennas to determine gain at required take-off angle and frequency. NOTE: The gain of the antennas is used to select the optimum antenna. Any of the antennas that meet the requirements (type of coverage, range, etc.) could be used.
- Select antenna that has highest gain at the required take-off angle that can be erected in the available site with the available materials

Example

If the circuit required a medium range directional antenna, four antennas could be used, OE-85/S6, long wire, sloping vee, or vertical half rhombic. The choice between these antennas is

based on the amount of space available for installation, the components available, and, probably most important, which antenna has the highest gain at the needed take-off angles. If the required take-off angle in this case is 25°, the frequency 9 MHz, the OE-85/86 or the 1000-ft vertical half rhombic would be the best choices because they provide the highest gain at the required take-off angle.

HF ANTENNA SELECTION MATRIX

	Page Number	Use			Directivity			Polarization		Bandwidth	
		Ground Wave	Skywave		Omnidirectional	Bidirectional	Directional	Horizontal	Vertical	Wide	Narrow
			Short (< 500 Miles)	Medium (500 to 1200 Miles)							
AS-2259/AS-2268	27		X		X					X	
OE-85/86	29			X	X			X		X	
Vertical Whip	31	X					X ^b	X		X	
Half Wave Dipole	35		X	X		X		X			X
Inverted Vee	41	X	X	X		X		X	X		X
Long Wire	43	X		X	X		X	X		X	
Inverted L	46	X	X	X		X	X	X	X		X
Sloping Vee	49			X	X			X		X	
Sloping Wire	52	X		X		X			X	X	
Vertical Half Rhombic	57	X		X	X				X	X	

^a The page number on the HF Antenna Selection Matrix shows where additional information concerning that antenna is located.

^b The vertical whip can be made directive by placing another vertical wire near it. See page 34 for details.

AS-2259/AS-2268

The AS-2259/AS-2268 antenna is designed to provide near vertical incident sky-wave (NVIS) propagation for short range radio circuits. The sole difference between the AS-2259 and the AS-2268 is that the AS-2268 includes a whip adapter kit (MX-9313). This antenna consists of two crossed sloping dipoles positioned at right angles to each other and supported at the center by a 15-foot mast. In use, the dipole elements provide guying support for the mast.

Characteristics	
Frequency Range	3 to 30 MHz
Polarization	Horizontal and Vertical Simultaneously
Power Capability	1000 watts
Radiation Pattern	
Azimuthal (bearing)	Omnidirectional
Vertical (Take-off angle)	See plot
Erection Time	2 persons in five minutes
Weight	14.7 lbs.
Installed Area	60 ft X 60 ft

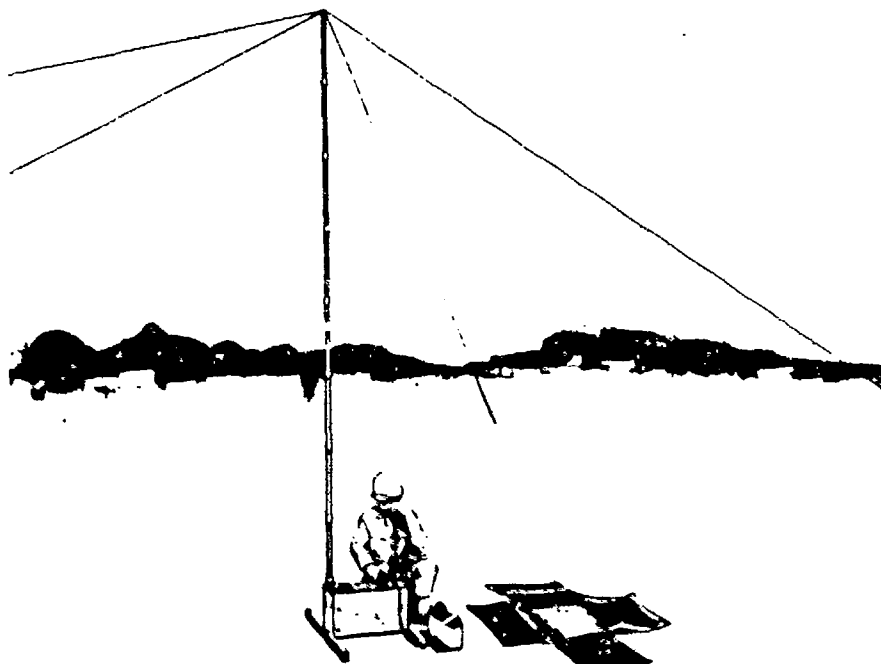

AS-2259 antenna.

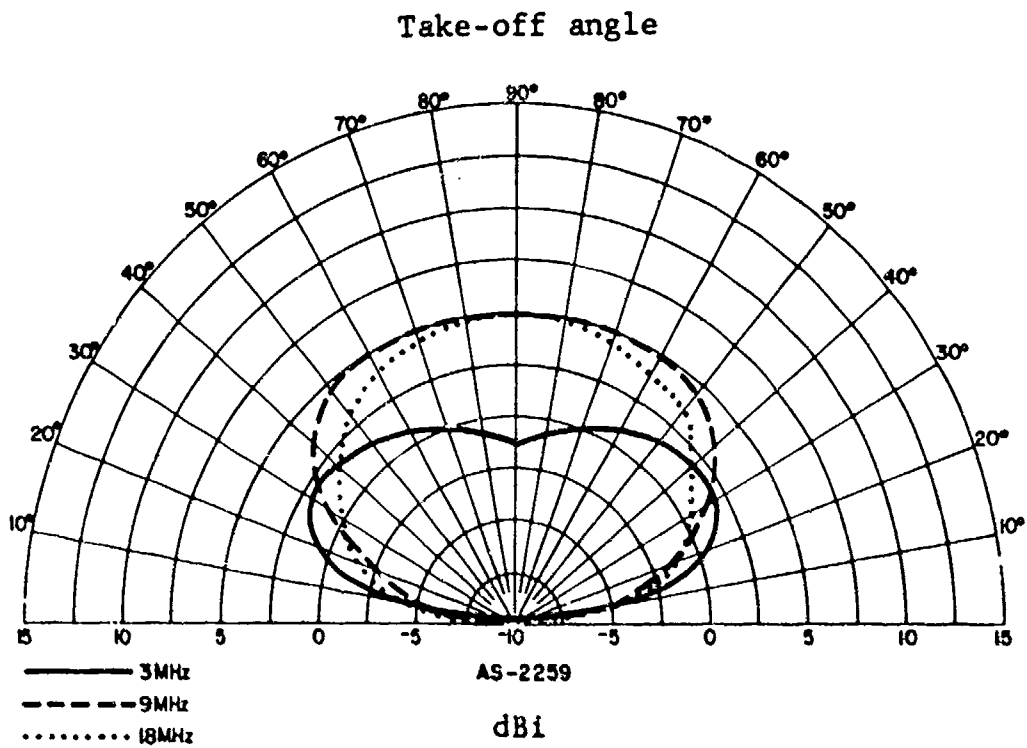

AS-2259 vertical radiation pattern.

OE-85/OE-86

The OE-85/OE-86's are horizontal log periodic antennas supplied as components of the AN/TSC-60 Communications Central. The OE-85 is rated at 3 kW and the OE-86 at 10 kW, otherwise the antennas are basically the same. This antenna provides a medium to long range directional capability to the AN/TSC-60.

Characteristics	
Frequency Range	2 to 30 MHz
Polarization	Horizontal
Power Capability	OE-85 3 kW OE-86 10 kW
Radiation Pattern	
Azimuthal (beams)	2 to 4 MHz: basically omnidirectional 4 to 30 MHz: directional (35° either side of radiation)
Vertical (Take-off angle)	See plot
Erection Time	5 persons in one hour
Weight	1270 lbs.
Installed Area	
Width	310 ft
Length	200 ft

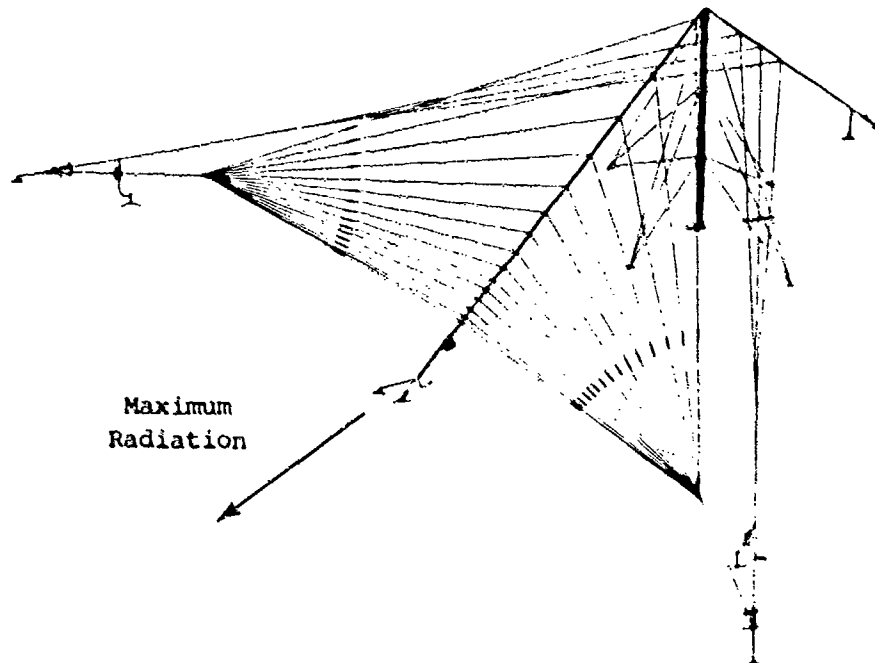

OE-85/86 antenna.

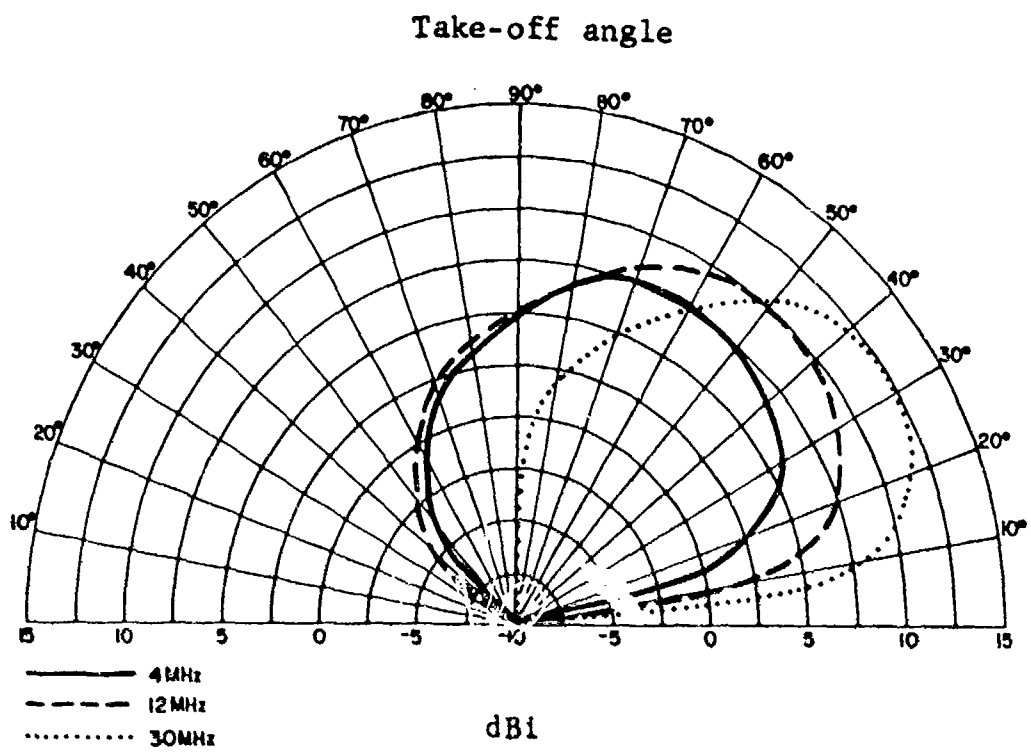

OE-85/86 vertical radiation pattern.

VERTICAL WHIP

The vertical whip is a component of all radio sets. Because it is available and easy to use, it is used on almost all radio circuits; however, it is probably the WORST antenna that can be used on sky-wave circuits. Unless the radio circuit involves omnidirectional ground-wave propagation, just about any other antenna would provide better communications. For example, vertical whips are often used for long range point-to-point circuits with marginal success. Since the circuit is point to point, there is no reason to be radiating energy in all directions; radiation in directions other than at the distant station is wasted and serves no useful purpose. If that omnidirectional radiation were concentrated at the distant station, not only would the received signal be better, but interference around the transmitting antenna would be reduced. Concentrating radiation in a single direction can be done with a directional antenna.

If a vertical whip must be used on a circuit, there are several techniques that may improve the antenna. The radio (if the antenna is mounted directly to the radio) or the antenna base plate (if the antenna is removed from the radio) must be grounded, preferably through a six-foot ground rod. Ground radials (wires spread out like spokes of a wheel with the antenna at the center) may improve the antenna radiation. These radials should be connected to the ground rod directly beneath the antenna.

A ground radial system can be easily constructed from field telephone wire (WD1/TT) and can be kept with the radio. The field wire is cut into twenty 45-foot lengths, and six inches of insulation are removed from one end. The ends of wire without insulation are bundled together with twine or a clamp. A 2-foot length of thick wire (the braid from RG-213 works well) is attached to the bare ends of the field wire so that the thick wire extends about one foot from the wire bundle. The wire bundle is then soldered to ensure good electrical contact. In use, the thick wire extending from the bundle is used to connect the radials to a ground rod. The radials are then spread out like spokes on a wheel with the vertical whip at the center. As is the case when using any ground radial system, communications should be tried both with and without the radials, and then continued with whichever provided the better communications.

Characteristics

Frequency Range	2 to 30 MHz
Polarization	Vertical
Power Capability	Matched to specific radio
Radiation Pattern	
Azimuthal (bearing)	Omnidirectional
Vertical (Take-off angle)	See plots

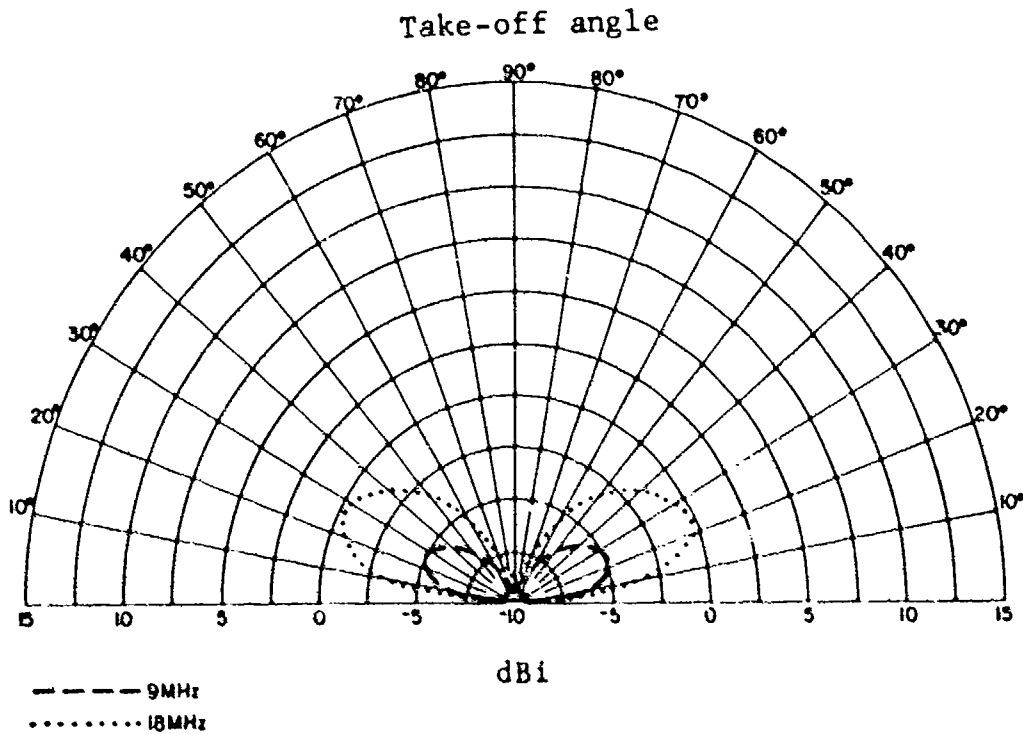

Ten-foot vertical whip vertical antenna pattern.

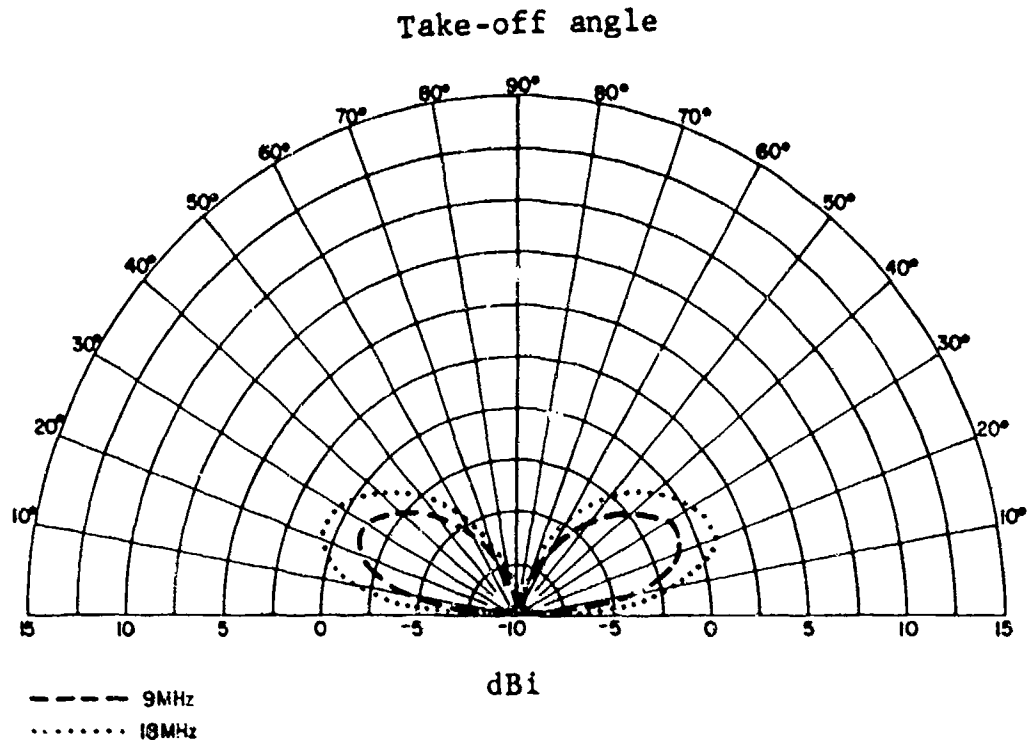

Fifteen-foot vertical whip vertical antenna pattern.

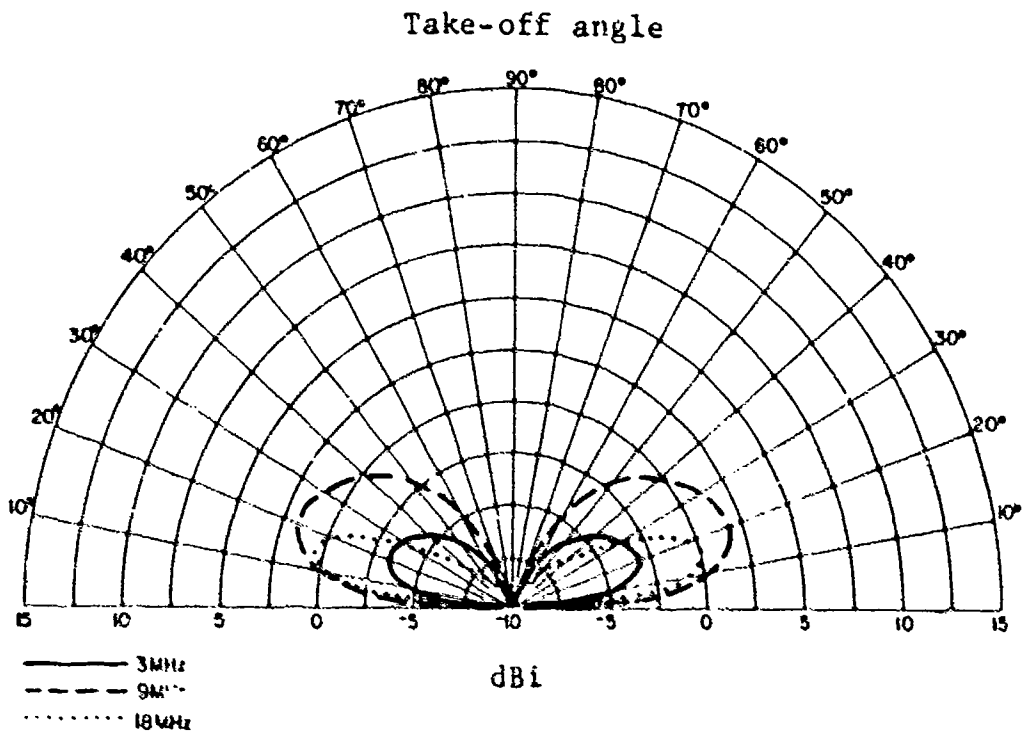

Thirty-two-foot vertical whip vertical antenna pattern.

A reflector placed approximately one-quarter wavelength behind a vertical whip may also improve the performance of a whip. A reflector is a vertical wire or metallic pole (or another whip) that is insulated from the ground. It is placed so that the reflector, the whip, and the distant station are on a straight line. The reflector will reflect radio energy striking it and cause the energy to travel toward the distant station, thereby increasing the total energy radiated in the desired direction. To work properly, the reflector must be longer than the whip. If the reflector is shorter, it will act as a director and cause the radio signal to be directed away from the distant station. Remember: a reflector is longer and is placed behind the whip; a director is shorter and is placed between the whip and the distant station. The position of the reflector should be adjusted while listening to the distant station until the strongest signal is received.

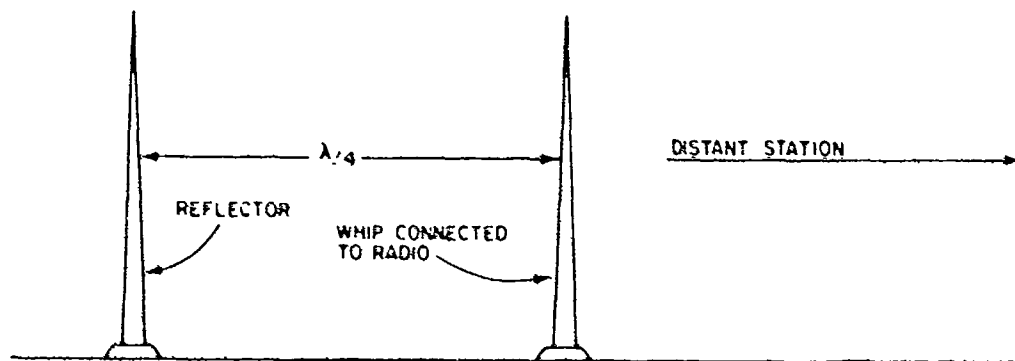

Vertical whip with reflector.

HALF-WAVE DIPOLE

The horizontal half-wave dipole antenna, or doublet, is used on short- and medium-length sky-wave paths (up to approximately 1200 miles). Since it is relatively easy to design and construct, the doublet is the most often used field expedient wire antenna. It is a very versatile antenna in that by adjusting the antenna's height above ground, the maximum gain can vary from medium take-off angles (for medium path-length circuits) to high take-off angles (for short path-length circuits). When the antenna is constructed for medium take-off angle gain (a height of approximately one-half wavelength), the doublet is a bidirectional antenna, that is, the maximum gain is at right angles to the wire. This is one "broadside" pattern normally associated with a half-wave dipole antenna. The illustration shows this pattern in polar plot format, A.

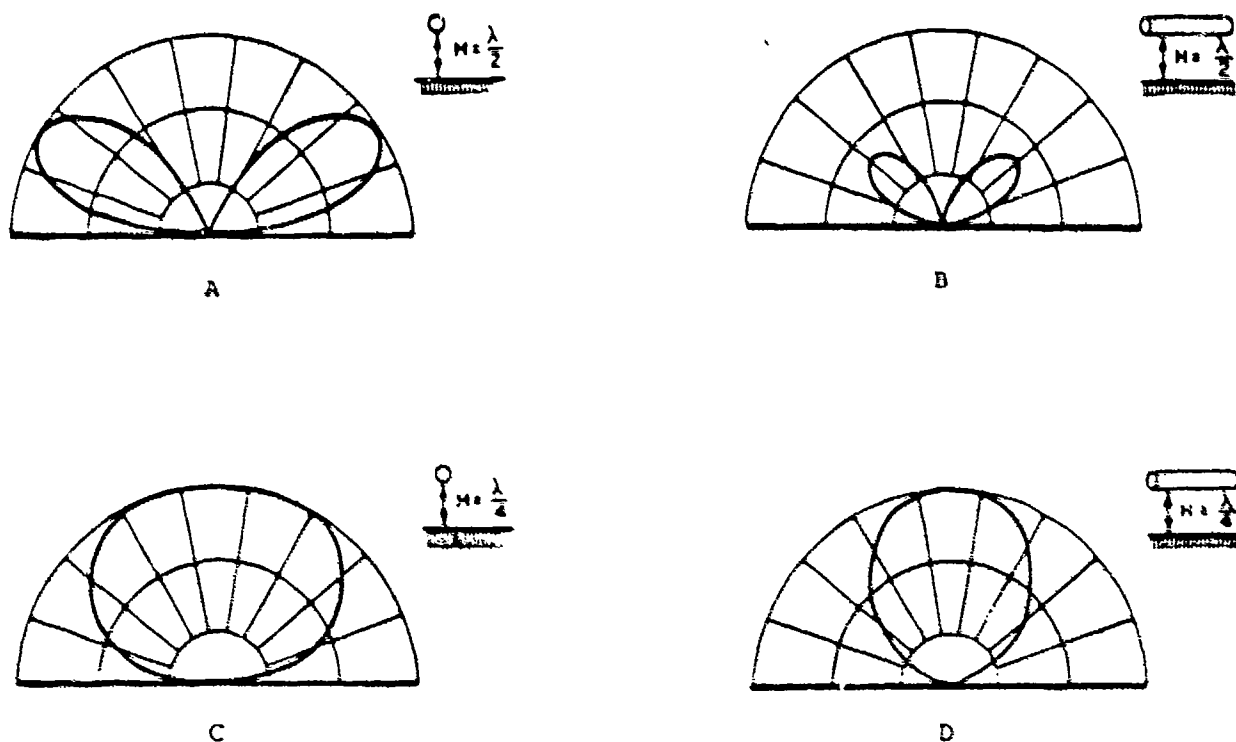

Illustrative doublet antenna patterns.

The radiation off the ends of the wire is shown in B. It is easily seen by comparing A and B that for maximum gain, a doublet one-half wavelength above ground should be constructed so that the side of the antenna points in the direction of the distant station. If the antenna were lowered to only one-quarter wavelength above ground, the pattern in C results. This lower antenna height produces maximum gain at high take-off angles. As can be seen in D, the radiation off the ends of the doublet also has maximum gain at high take-off angles. This means that for short path-length circuits, which require high take-off angles, a doublet antenna one-quarter wavelength above ground produces almost omnidirectional coverage.

The vertical plots included for half-wave dipole antennas are given for heights from 8 to 16 meters. In looking at the plot for 8 meters, it can be seen that for 3 and 9 MHz the antenna has high-angle radiation since at those frequencies the antenna is close to ground (compared to a half wavelength). The pattern for 18 MHz shows the characteristic bidirectional pattern since 8 meters is a half wave at 18 MHz.

The half-wave dipole is a balanced resonant antenna. This means that it will produce its maximum gain for a very narrow range of frequencies, normally 2% above and below the design frequency. Since frequency assignments are normally several megahertz apart, it is necessary to construct a separate dipole for each frequency assigned. If space and other resources do not exist to erect separate dipoles, three or four dipoles can be combined to occupy the space normally required for one.

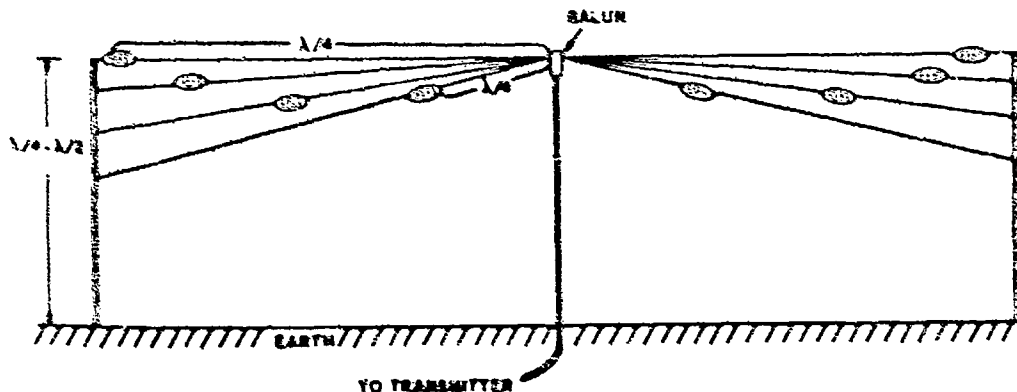

Multifrequency doublet.

Each wire is a half-wavelength for an assigned frequency. All the separate dipoles are connected to the same center insulator, or preferably a balun, and are fed by a single coaxial cable. When the antenna is fed with an assigned frequency, the doublet cut for that frequency will radiate the energy. Up to four separate dipoles can be combined in this manner. When constructing this antenna, the individual frequency assignments should be examined to determine if one frequency is three times as large as another. If this relationship exists between two frequencies, one dipole cut in length for the lower of the two frequencies will work well for both frequencies.

The length of a half-wave dipole is calculated from the following relationship

$$\begin{aligned} \text{Dipole length} &= \frac{142}{f \text{ (MHz)}} \text{ meters or} \\ &= \frac{468}{f \text{ (MHz)}} \text{ feet} \end{aligned}$$

The height of a half-wave dipole is figured using:

$$\text{Height: } \lambda/4 = \frac{75}{f \text{ (MHz)}} \text{ meters or } \frac{246}{f \text{ (MHz)}} \text{ feet}$$

$$\text{Height: } \lambda/2 = \frac{150}{f \text{ (MHz)}} \text{ meters or } \frac{492}{f \text{ (MHz)}} \text{ feet}$$

Remember to use the right relationship for the right purpose. If the height relationship is used for the dipole length, the antenna would be too long and would not work properly.

Characteristics	
Frequency Range	± 2% of design frequency
Polarization	Horizontal
Power Capability	1000 watts
Radiation Pattern	
Azimuthal (Bearing)	Bidirectional if $\lambda/2$ high basically omnidirectional at $\lambda/4$ high
Vertical (Take-off angle)	See plots

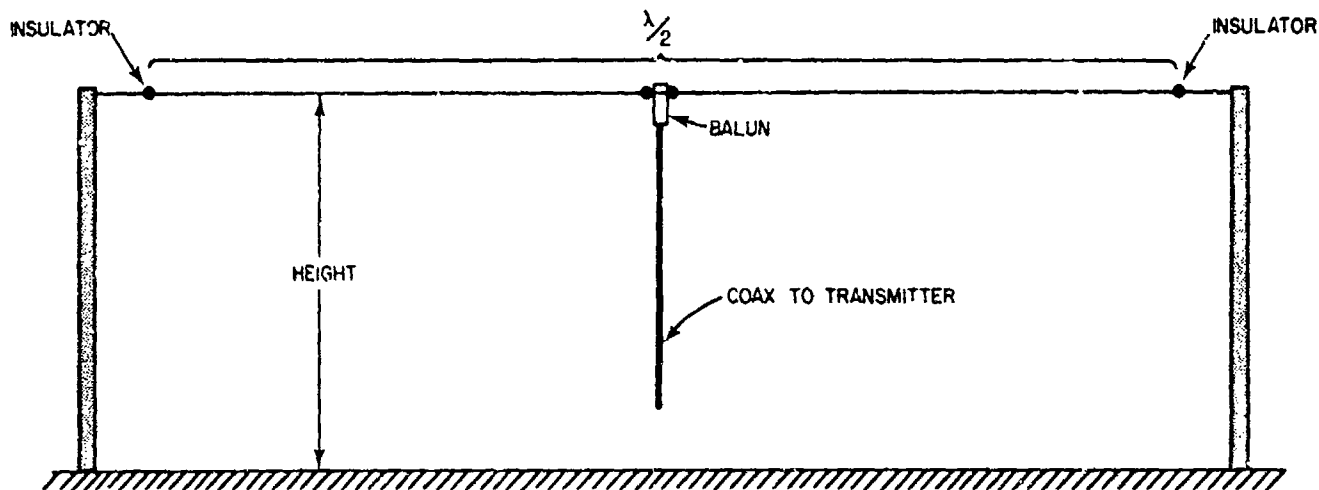

Half-wave dipole antenna.

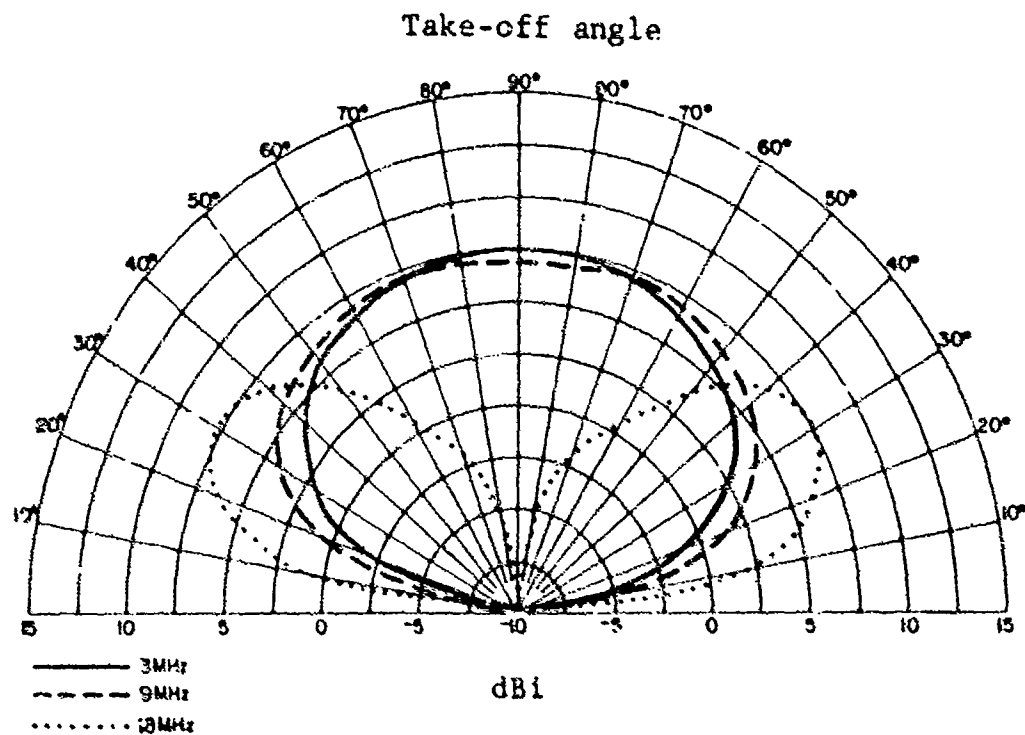

Half-wave dipole antenna vertical pattern, height 8 meters.

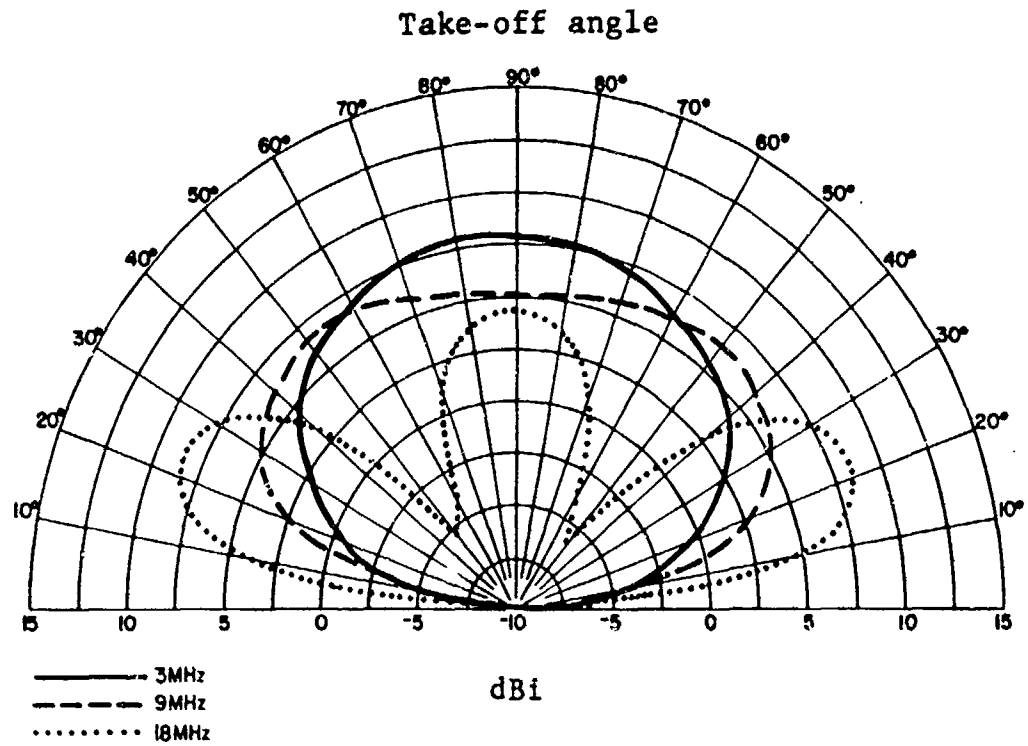

Half-wave dipole antenna vertical pattern, height 10 meters.

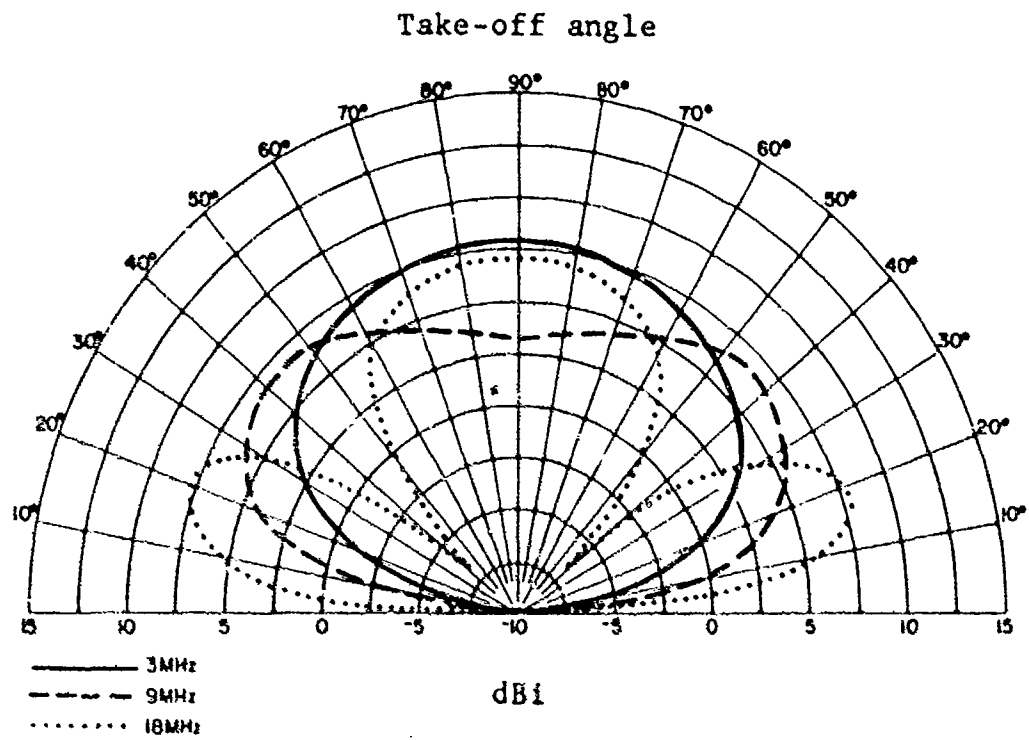

Half-wave dipole antenna vertical pattern, height 12 meters.

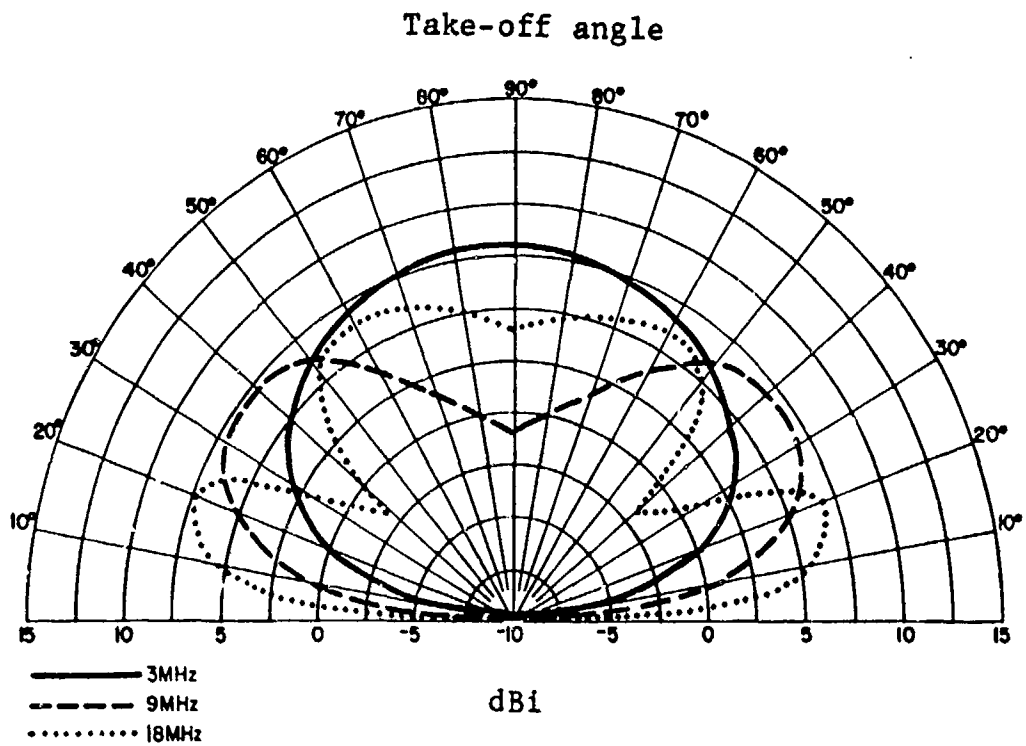

Half-wave dipole antenna vertical pattern, height 14 meters.

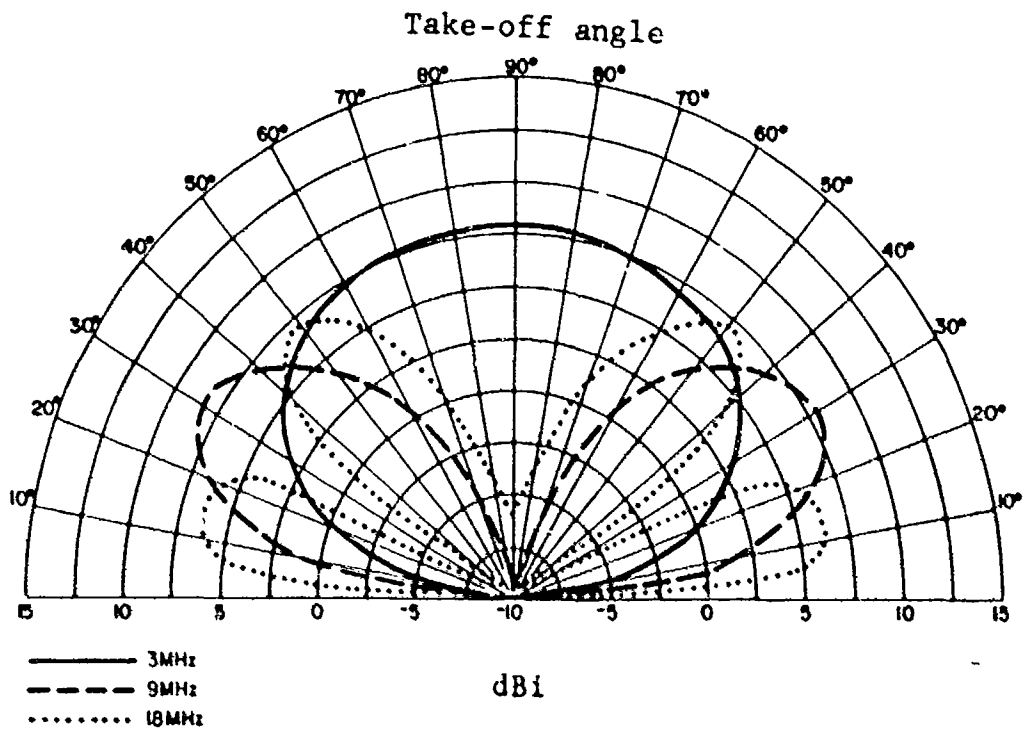

Half-wave dipole antenna vertical pattern, height 16 meters.

INVERTED VEE

The inverted vee, or drooping dipole, is similar to a dipole but uses only a single center support. Like a dipole, it is designed and cut for a specific frequency and has a bandwidth of $\pm 2\%$ of design frequency. Because of the inclined sides, the inverted vee antenna produces a combination of horizontal and vertical radiation; vertical off the ends and horizontal broadside to the antenna. All the construction factors for a dipole also apply for the inverted vee. The inverted vee has less gain than a dipole but the use of only a single support could make this antenna the preferred antenna in some tactical situations.

Characteristics	
Frequency Range	$\pm 2\%$ of design frequency
Polarization	Vertical off the ends Horizontal broadside
Power Capability	1000 watts
Radiation Pattern	
Azimuthal (Beaming)	Basically omnidirectional with combination polarization
Vertical (Take-off angles)	See plots

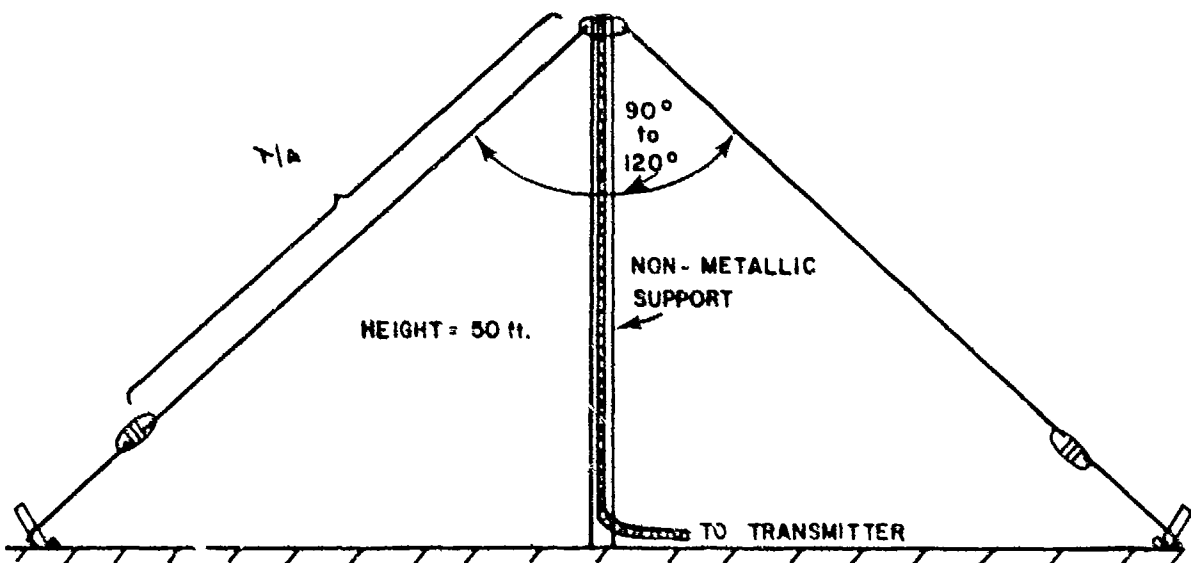

Inverted vee antenna.

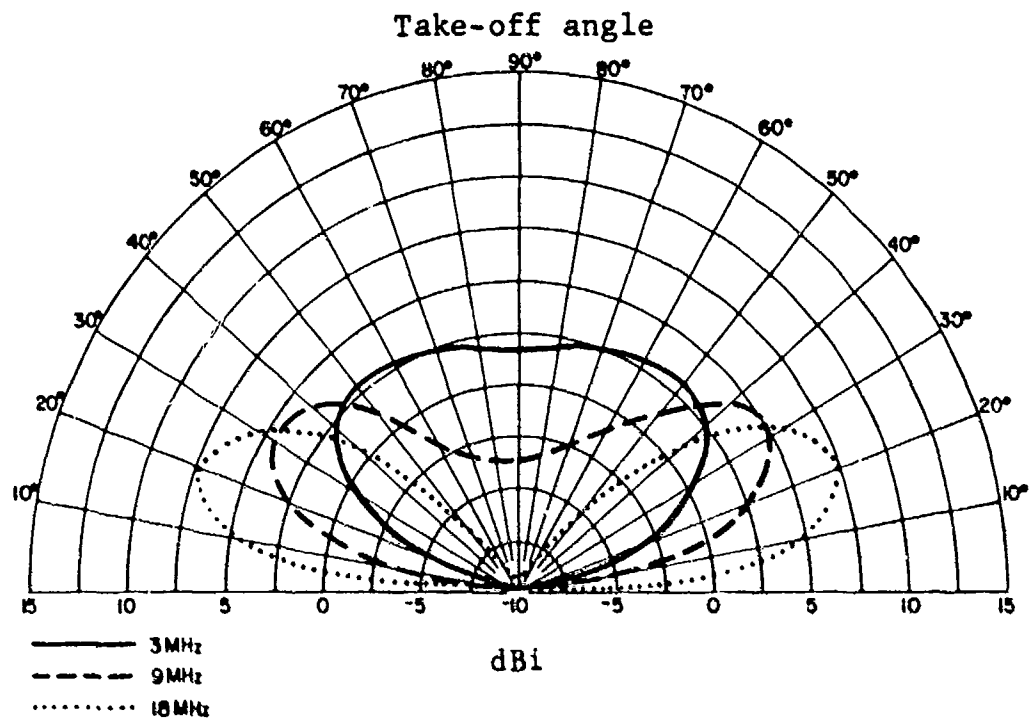

Inverted vee antenna vertical pattern.

LONG WIRE

A long-wire antenna is one that is long compared to a wavelength. A minimum length is one-half wavelength, however, antennas that are at least several wavelengths long are needed to obtain good gain and directional characteristics. The construction of long-wire antennas is simple and straight forward, and there are no especially critical dimensions or adjustments. A long-wire antenna will accept power and radiate it well on any frequency for which its overall length is not less than one-half wavelength.

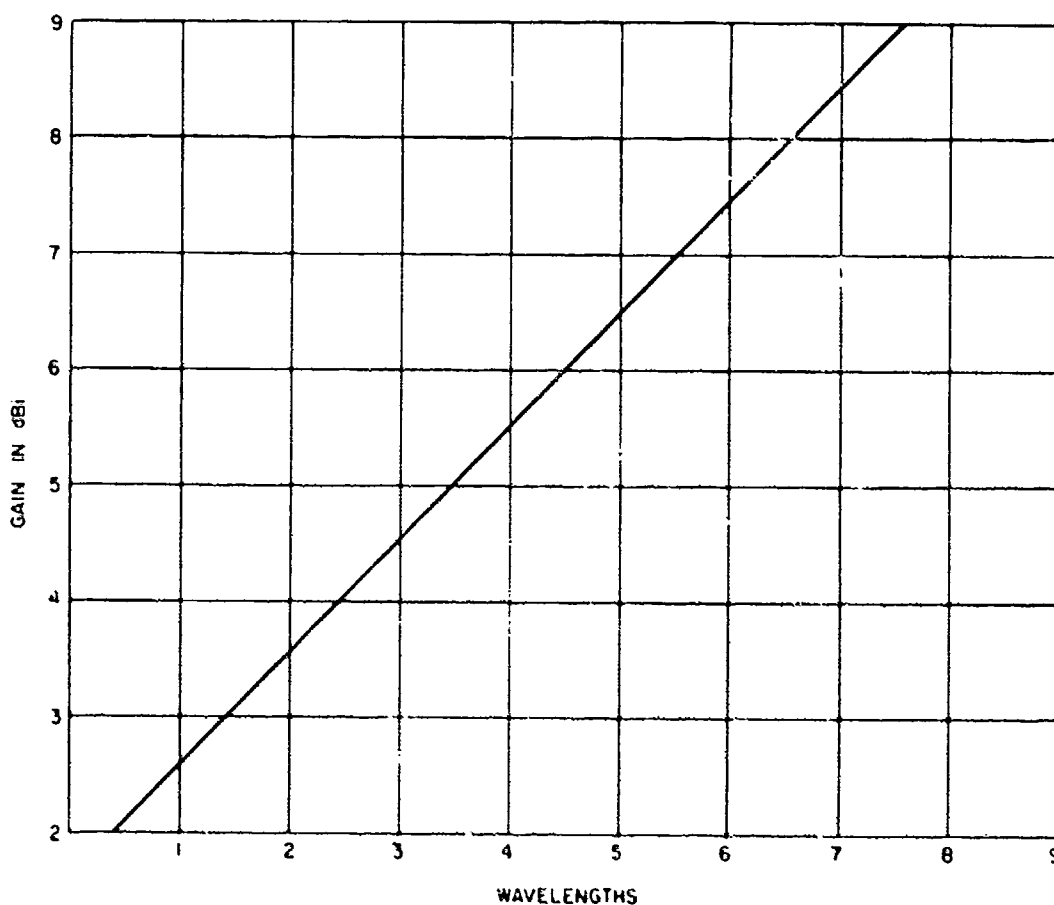

Gain of a long-wire antenna as determined by length.

The gain and take-off angle of a long-wire antenna are dependent on the antenna's length. The longer the antenna, the more gain and the lower the take-off angle. Gain has a simple relationship to length; however, take-off angle is a bit more complicated. A long-wire antenna radiates a cone of energy around the wire, much like a funnel with the antenna wire passing through the funnel opening. The narrow part of the funnel would be the feed point and the open part would be towards the distant station. If the funnel were cut in half, the resulting half cone would represent the pattern of the antenna. As the antenna is made longer, the cone of radiation (funnel) would move closer and closer to the wire itself. The below patterns show how the pattern changes as the wire becomes longer. The patterns represent what would be seen looking up from directly underneath

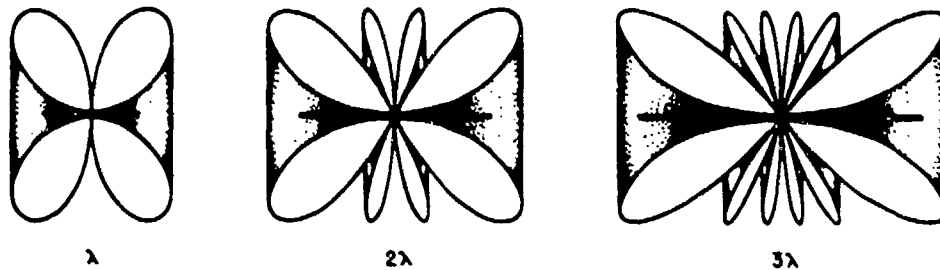

Long-wire antenna radiation patterns.

the antenna. Looking at the three-wavelength pattern (3λ), it can be seen that for very low-angle radiation, the wire would have to be positioned somewhat away from the direction of the distant station so that the main lobe of radiation is pointed at the receiving station. If a higher take-off angle were required for communications, the wire could be pointed directly at the distant station. Different antenna lengths produce different take-off angles so that the range of take-off angles as well as the desired gain must be considered when determining a long-wire antenna's length. For take-off angles from 5° to 25° the following general off-axis angles will provide satisfactory radiation toward the distant station.

	Wire Length (λ)				
	2	3	4	5	6
Off-Axis Angle	30	20	13	10	10

A long-wire antenna can be made directional by placing a terminating device at the distant station end of the antenna. The terminating device should be a 600-ohm noninductive resistor capable of absorbing at least one-half of the transmitter

power. Terminating resistors are components of some radio sets and can also be locally fabricated using supply system components. (NSN 5905-00-764-5573, 100-watt 106-ohm resistor).

Construction of a long-wire antenna requires only wire, support poles, insulators, and a terminating resistor (if directionality is desired). The only requirement is that the antenna be strung in as straight a line as the situation permits. The height of the antenna is only 15 to 20 feet above ground so that tall support structures are not required. The antenna is normally fed through a coupler that can match the antenna's 600-ohm impedance. Coaxial cable can be used if a 12:1 balun is available to convert the coaxial cable 50-ohm impedance to the required 600 ohms.

Vertical radiation plots of this antenna are not presented because of the great variation in the pattern as the length changes. For take-off angles between 5° and 25°, the off-axis graph can be used along with the gain versus length graph to determine what length of antenna to use.

Characteristics	
Frequency Range	2 to 30 MHz
Polarization	Vertical
Power Capability	1000 watts
Radiation Pattern	
Azimuthal (Bearing)	Bidirectional
Vertical	Directional with terminating resistor
(Take-off angle)	Dependent on length

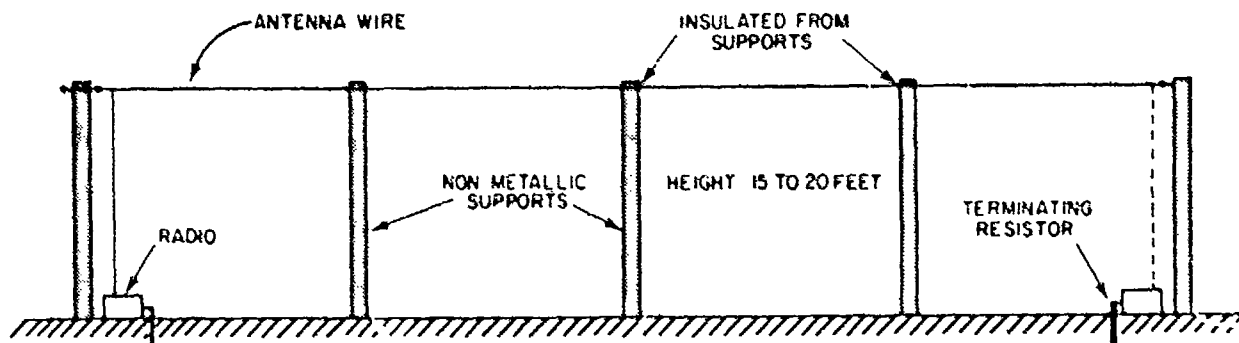

Long-wire antenna.

INVERTED L

The inverted L is a combination antenna made up of a vertical section and a horizontal section. It provides omnidirectional radiation for ground-wave propagation from the vertical element and high-angle radiation from the horizontal element for short-range sky-wave propagation. The classic inverted L has a quarter-wave vertical section and a half-wave horizontal section and was used for a very narrow range of frequencies. By using the antenna couplers that are part of many radio sets, the dimensions of the inverted L can be modified to allow ground-wave and short-range sky-wave propagation over a range of frequencies. Using a vertical height of 35 to 40 feet, the following horizontal lengths will give reasonable performance for short range sky-wave circuits.

Frequency Range (MHz)	Horizontal Length (feet)
2.5 to 4.0	150
3.5 to 6.0	100
5.0 to 7.0	80

The antenna should be oriented like a dipole, that is, the broad side of the antenna should be towards the distant station. These lengths should not be used outside the frequency ranges specified because the antenna radiation pattern changes, and for frequencies much removed from the range the antenna will become directional off the wire end. (See the sloping wire section for use of this directional characteristic). The inverted L antenna can be used as a substitute for the dipole; however, it has less gain than a dipole and its radiation pattern varies with frequency (unlike a dipole).

Characteristics	
Frequency Range	Less than 2:1 over design frequency
Polarization	Vertical from vertical section Horizontal from horizontal section
Power Capability	1000 watts
Radiation Pattern	
Azimuthal (Bearing)	Omnidirectional
Vertical (Take-off angle)	See plots

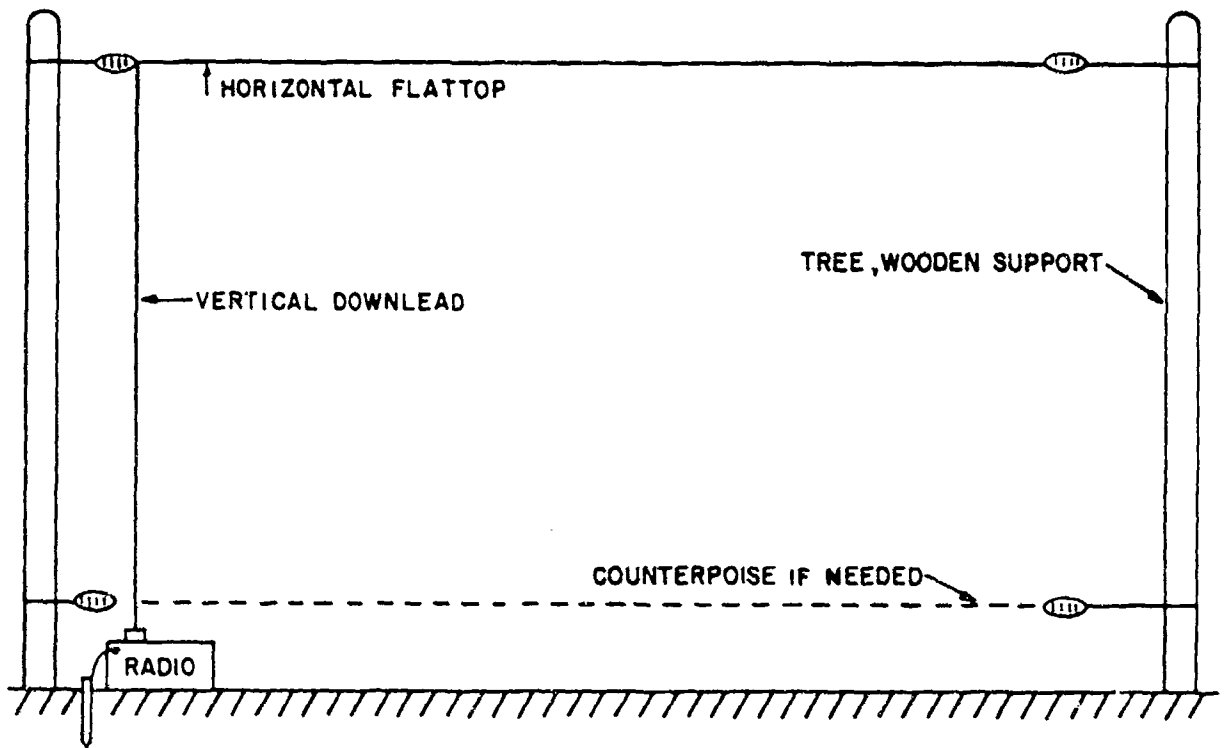

Inverted L antenna.

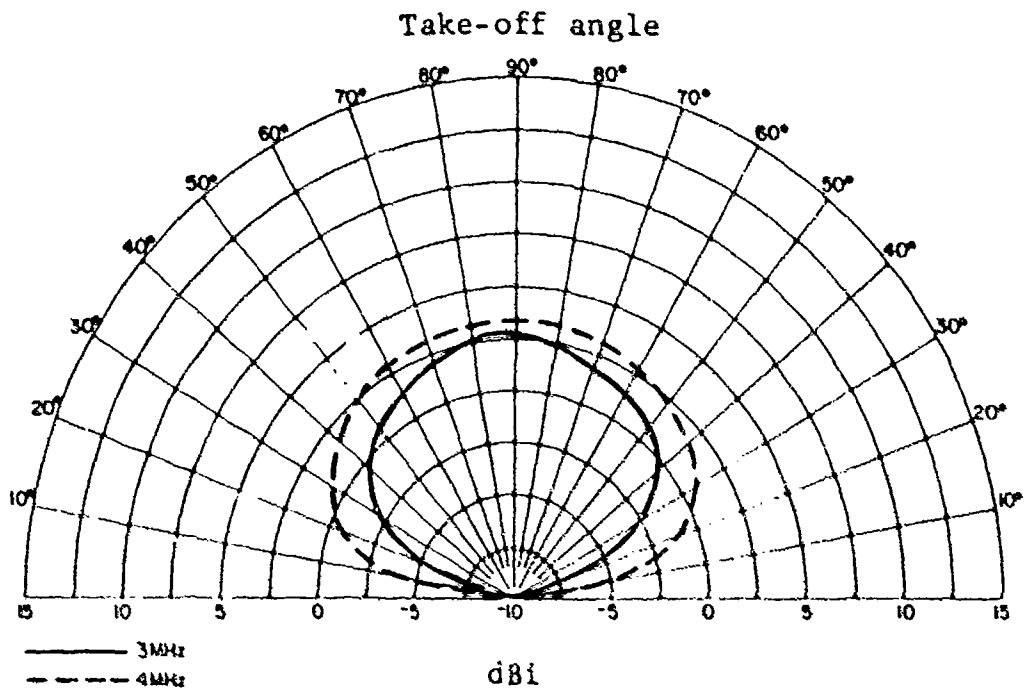

Inverted L antenna, vertical pattern, height 40 feet, length 150 feet.

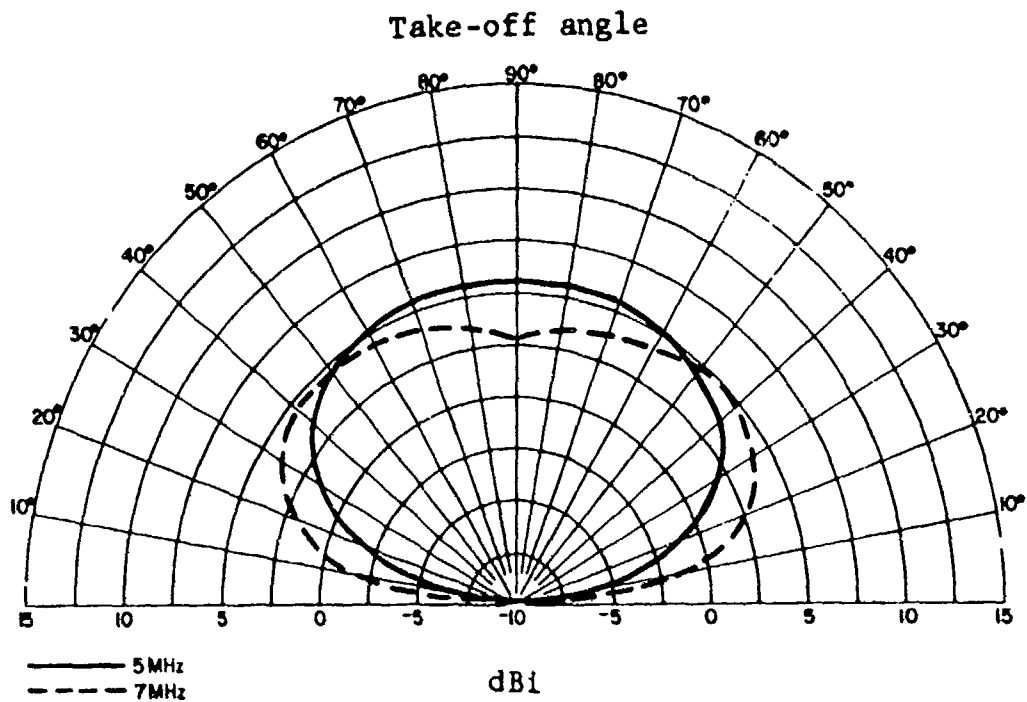

Inverted L antenna vertical pattern, height 40 feet,
length 80 feet.

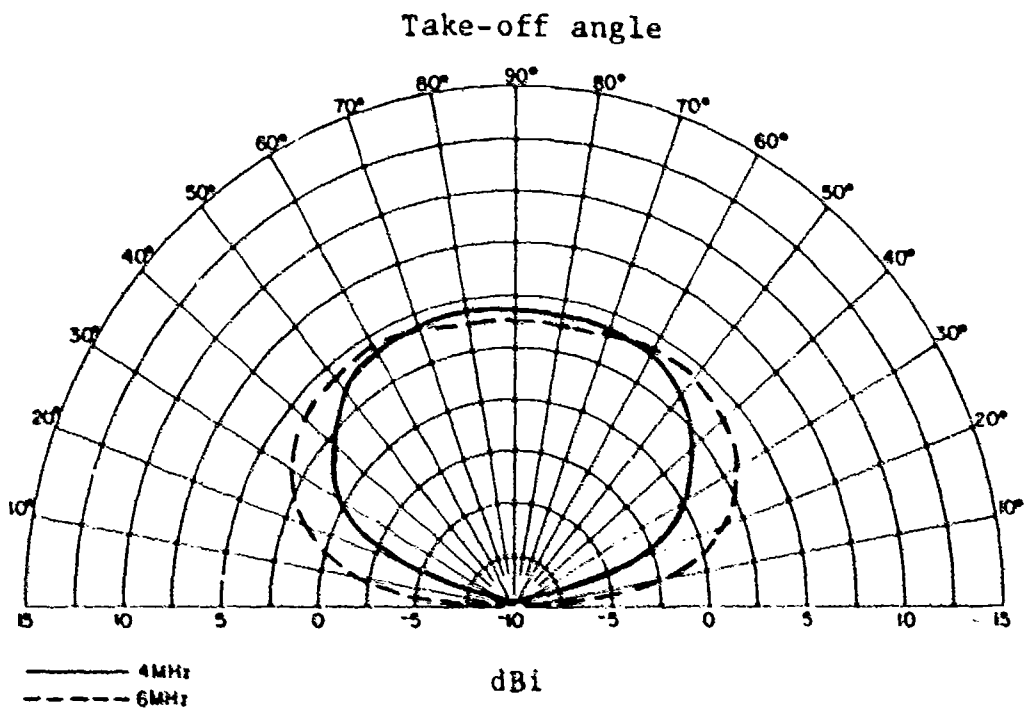

Inverted L antenna vertical pattern, height 40 feet,
length 100 feet.

SLOPING VEE

The sloping vee is a medium to long range sky-wave antenna that is reasonably simple to construct in the field. The gain and directivity of the antenna depend on the leg length. For reasonable performance, the antenna should be at least one wavelength long and preferably several wavelengths long.

A compromise tactical sloping vee can be constructed using 500-foot legs and a 40-foot support mast. In this case, the angle between the two legs is adjusted to provide maximum radiation at the desired take-off angle. The following angles between legs (apex angle) will give good results for the distances indicated.

Path Length	Apex Angle
700 to 1000 miles	60°
1000 to 1500 miles	45°
over 1500 miles	30°

To make the antenna directional, terminating resistors are used on each leg on the open part of the vee. The terminating resistors should be 300 ohms and be capable of handling one half of the transmitter's power output. These terminations are either procured or are locally fabricated using supply system parts (100-watt, 106-ohm resistor NSN 5905-00-764-5573). Using the terminating resistors, the antenna is aimed so that the line cutting the vee in half is pointed at the distant station.

The sloping vee is normally fed with a 600-ohm open-wire feed line. One side of the feedline is connected to one leg with the other side connected to the other leg. The open-wire feed line can be connected to a 12:1 balun, which is then connected to standard coaxial cable.

Characteristics	
Frequency Range	3 to 30 MHz
Polarization	Horizontal
Power Capability	Dependent on terminating resistors
Radiation Pattern	
Azimuthal (Bearing)	Directional (20° either side of direction of radiation)
Vertical (Take-off angle)	See plots

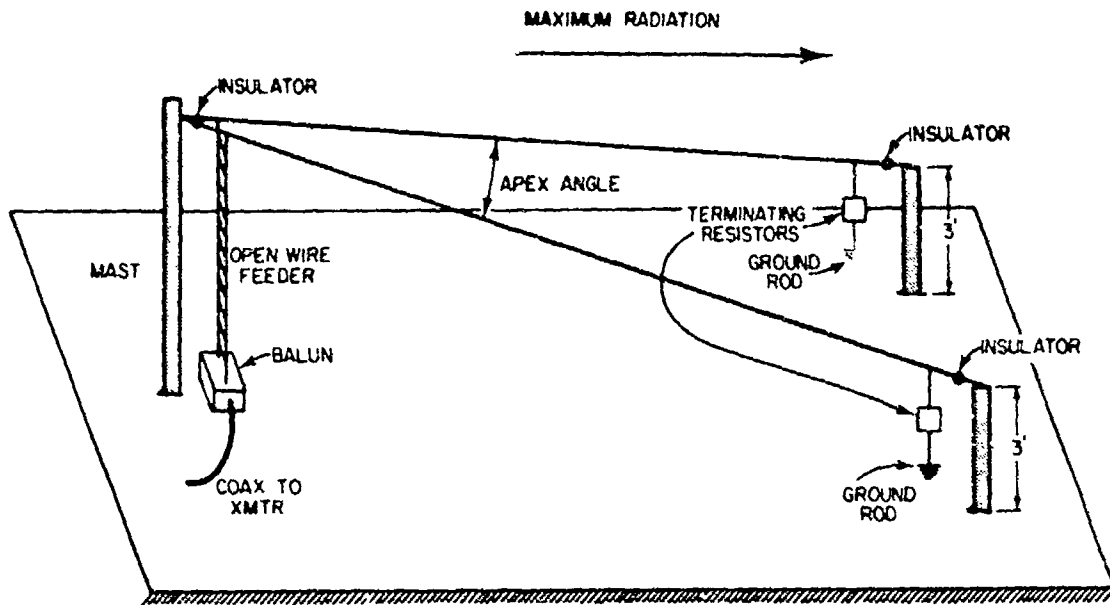

Terminated sloping vee antenna.

Take-off angle

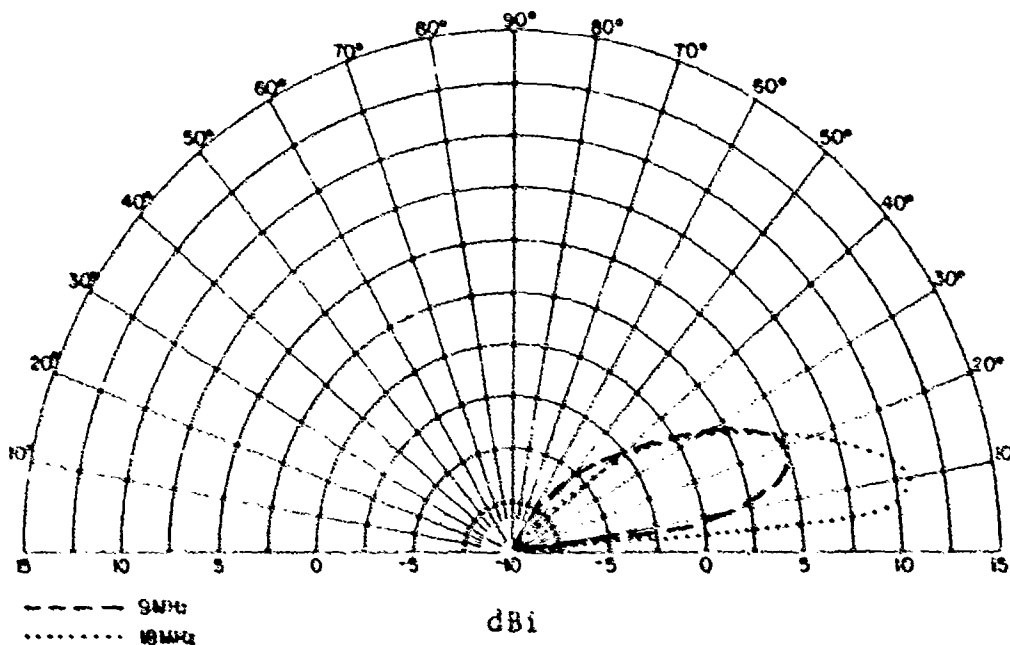

Terminated sloping vee antenna vertical pattern, height 40 feet, length 500 feet, apex angle 30°.

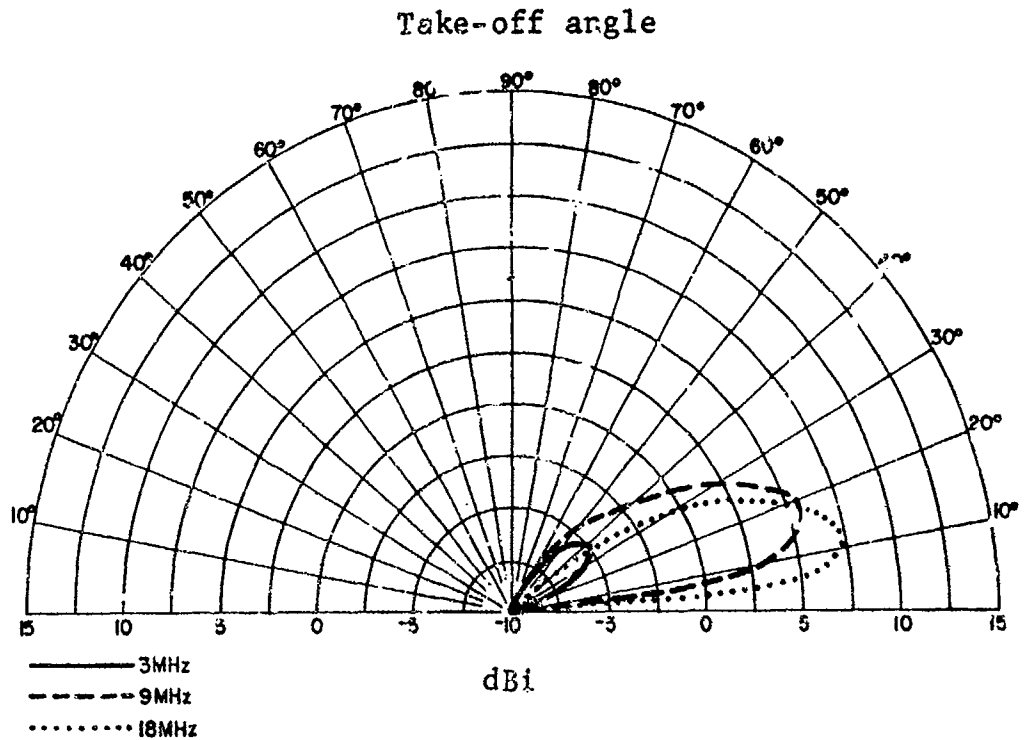

Terminated sloping vee antenna vertical pattern,
 height 40 feet, length 500 feet, apex angle 45°.
 Take-off angle

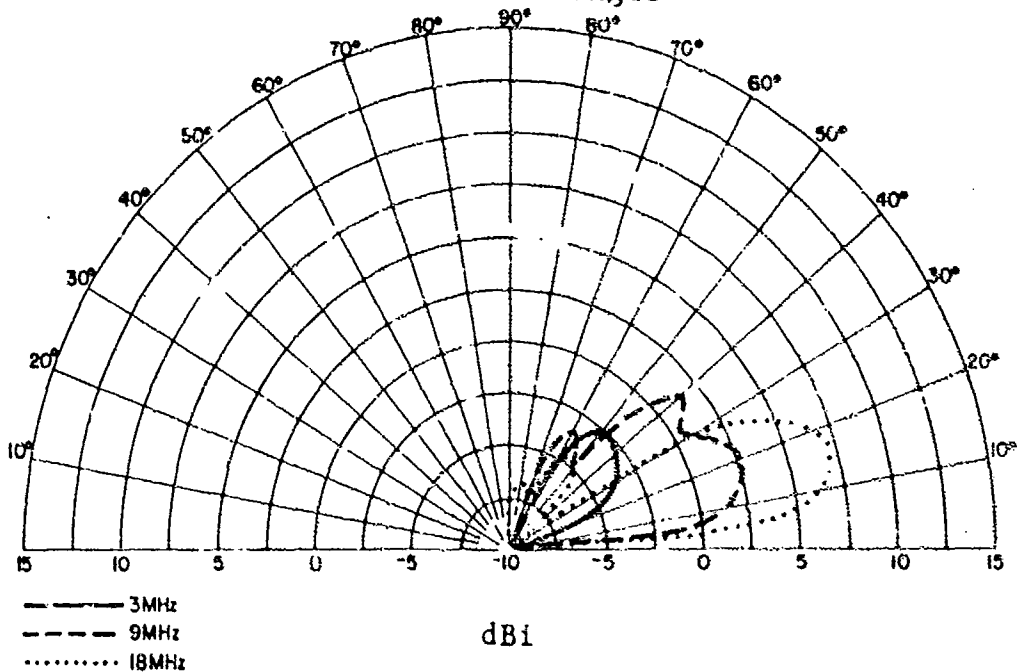

Terminated sloping vee antenna vertical pattern,
 height 40 feet, length 500 feet, apex angle 60°.

SLOPING WIRE

The sloping wire antenna is a simple and easy to construct antenna that requires only one support. A version of the long-wire antenna, the sloping wire produces best results when it is long compared to a wavelength. Tactical sloping wires vary in length from 45 feet to over 500 feet. The shorter lengths should be used only when no other antenna can be erected since their performance is rather poor. The longer lengths (250 feet, 500 feet) can produce good radiation for medium to long sky-wave paths.

A sloping wire can be either terminated or unterminated. If a 600-ohm termination is available, it should be used because this makes the antenna impedance fairly constant and a balun can be used to match the antenna to a transmitter. If the antenna is unterminated, a coupler will be required to match the transmitter to the antenna.

Variations of the sloping wire have been developed which work well for medium to long range circuits. Two of these, the AFWONXX Longwire and the 234-foot SF Wire, have been used on deployments and have demonstrated their usefulness. The AFWONXX Longwire is a 500-foot terminated sloping longwire antenna that provides reasonable gain and directivity. It has a fairly constant 600-ohm impedance so that it can be fed either through a coupler or with a 12:1 balun. If a balun is used, one terminal of the balun is connected to the antenna and the other terminal is connected to a good ground. Like a long wire antenna, this antenna should not be pointed directly at the receiving station, but should be aimed at a point 10° to 15° to the right or left of the distant station.

The 234-foot SF Wire is like the AFWONXX Longwire except it is only 234 feet long. It produces less gain than the AFWONXX Longwire, but the shorter length may make it preferable in some tactical situations. The 234-foot SF Wire provides reasonable radiation for medium to long range sky-wave circuits for the frequency range of 8 to 30 MHz. Like other long wire antennas, it should be aimed 10° to 15° to either side of the distant station.

In orienting a sloping wire, the low end of the wire should be toward the receiving station. If the wire is unterminated, the antenna should be fed at the low end. If a terminating resistor is used, the antenna is fed at the high end.

Characteristics	
Frequency Range	Dependent on wire length/configuration
Polarization	Vertical
Power Capability	Determined by terminating resistor
Radiation Pattern	
Azimuthal (Bearing)	Bidirectional for unterminated Directional for terminated
Vertical (Take-off angle)	See plots

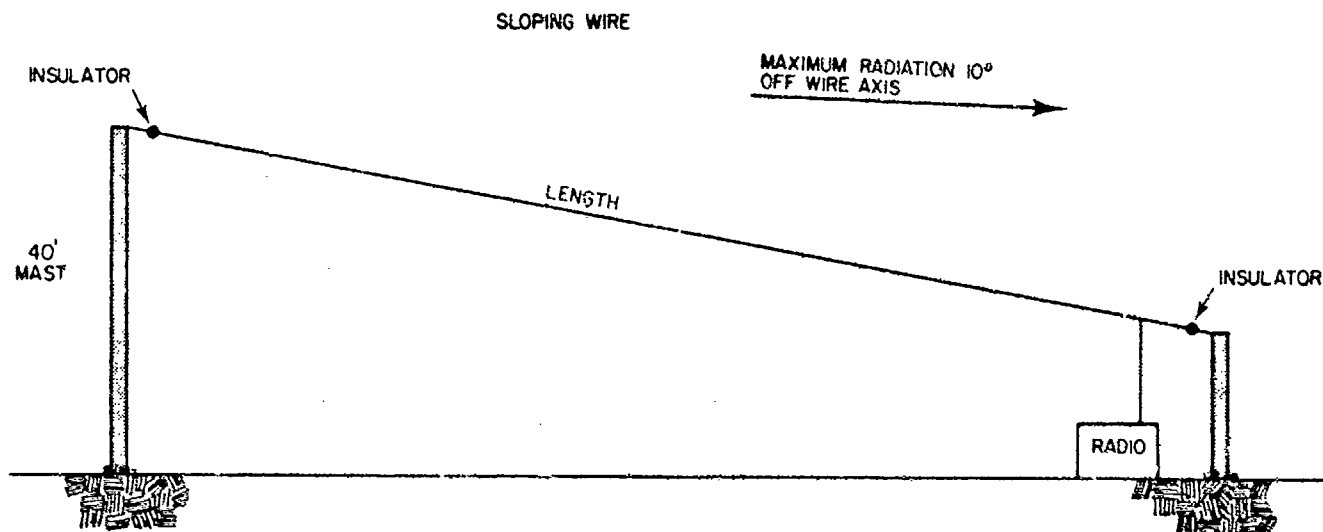

Sloping wire antenna, 40-foot mast.

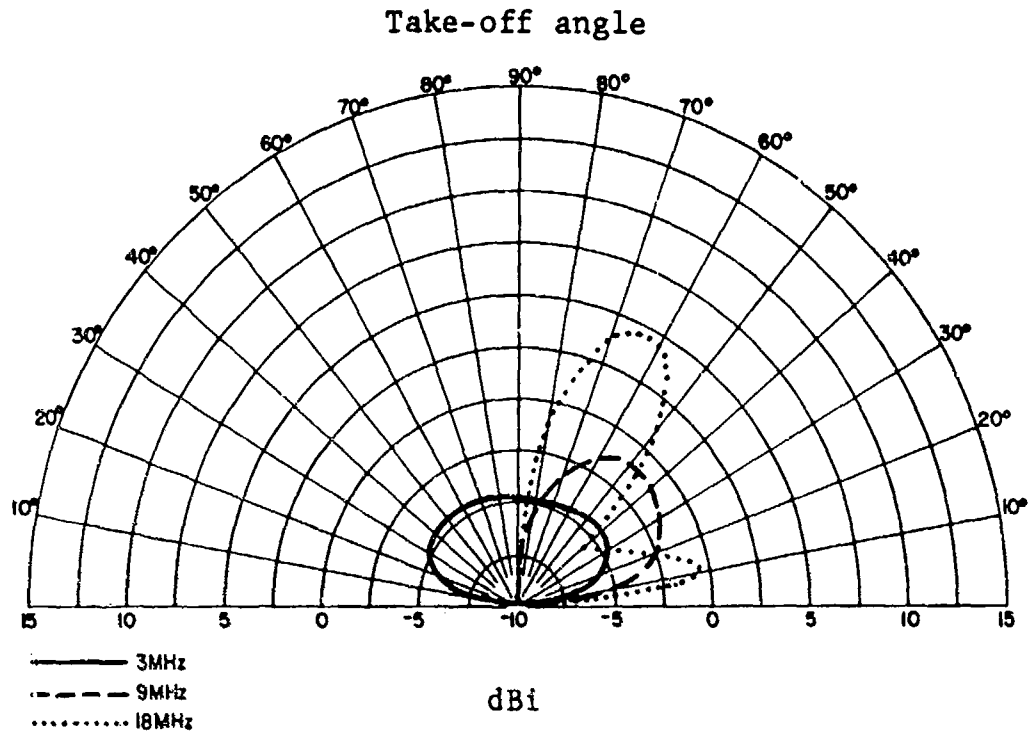

Sloping wire antenna vertical pattern, length 100 feet.

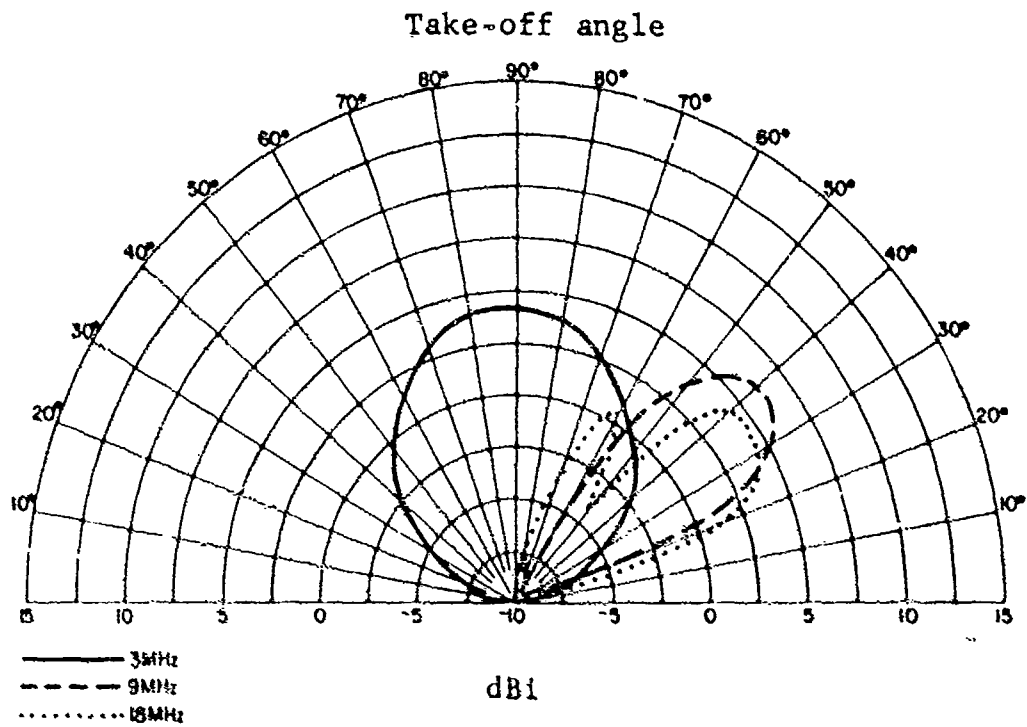

Sloping wire antenna vertical pattern, length 250 feet.

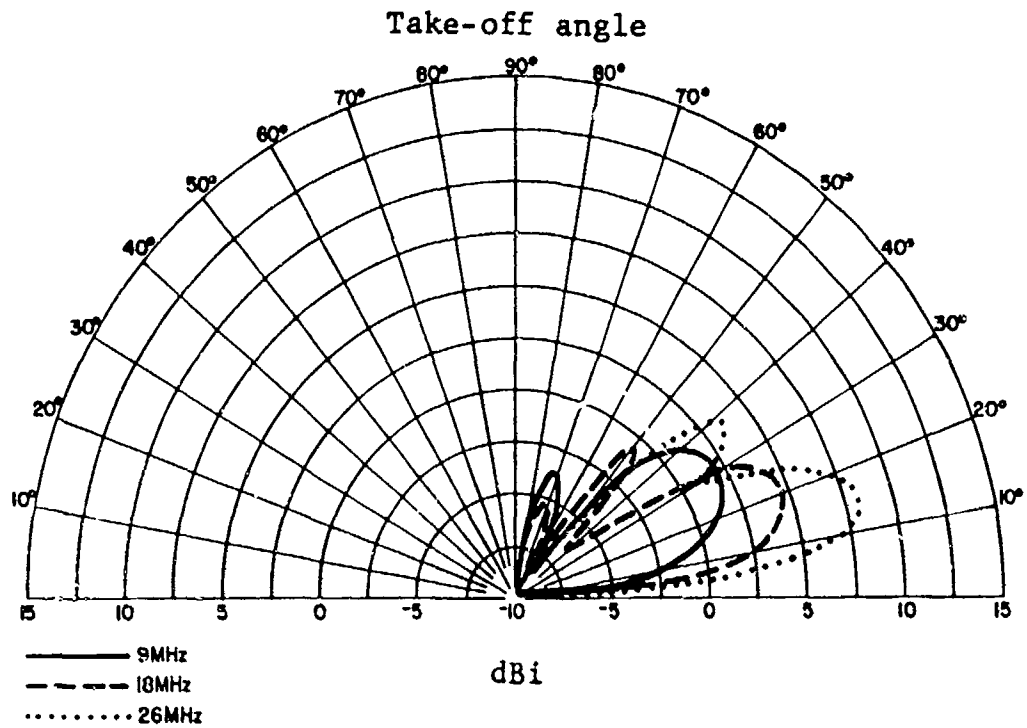

Sloping wire antenna vertical pattern, length 234 feet.

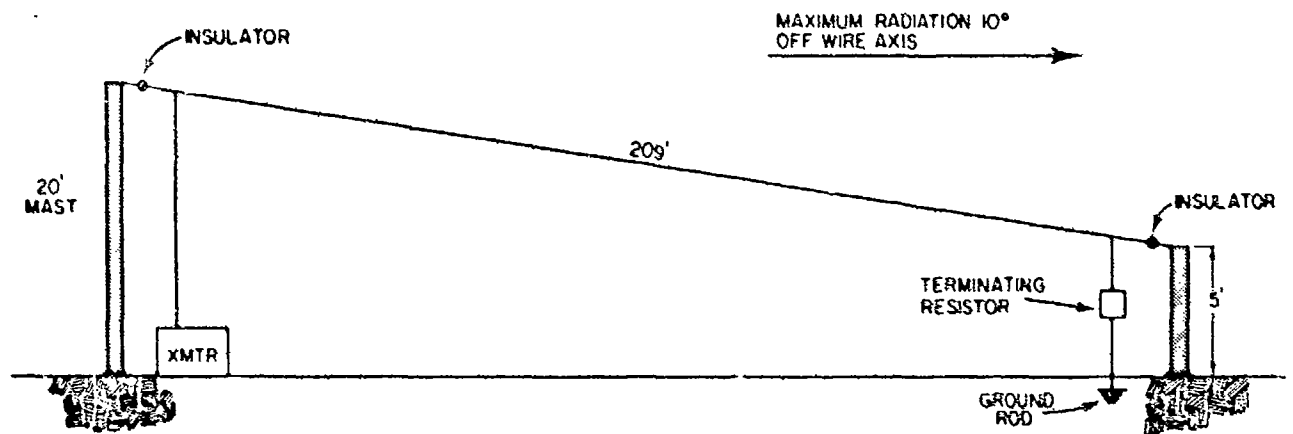

Two-hundred-thirty-four-foot sloping wire antenna.

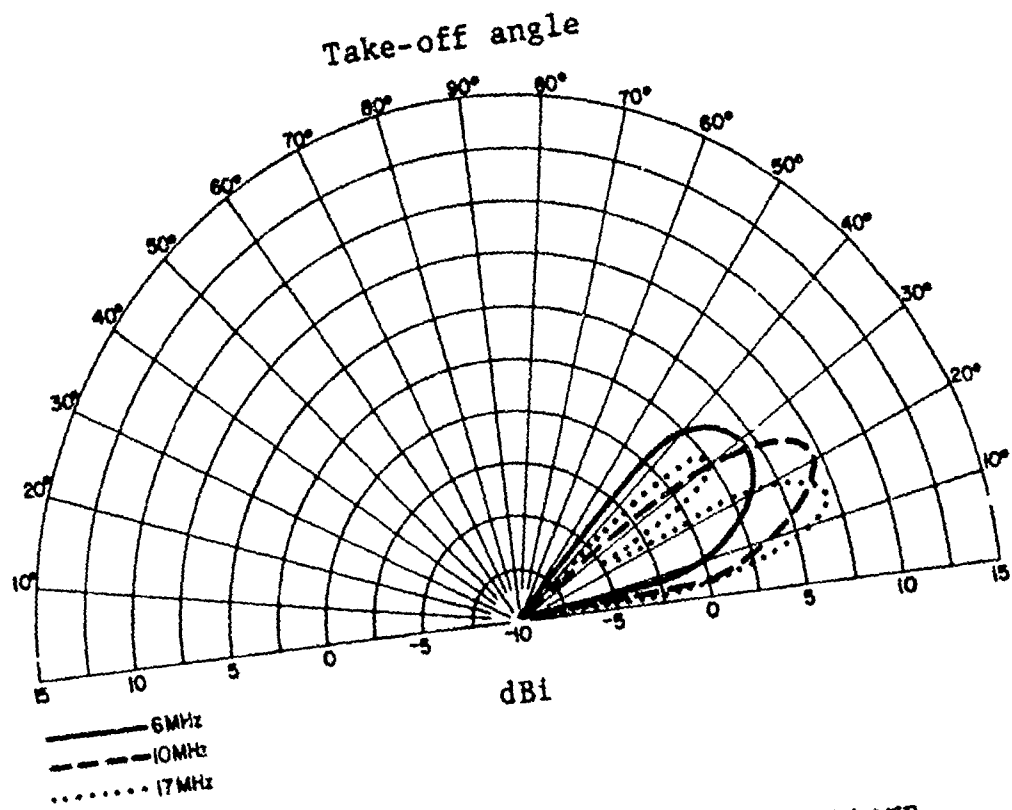

AFWONXX longwire antenna vertical pattern.

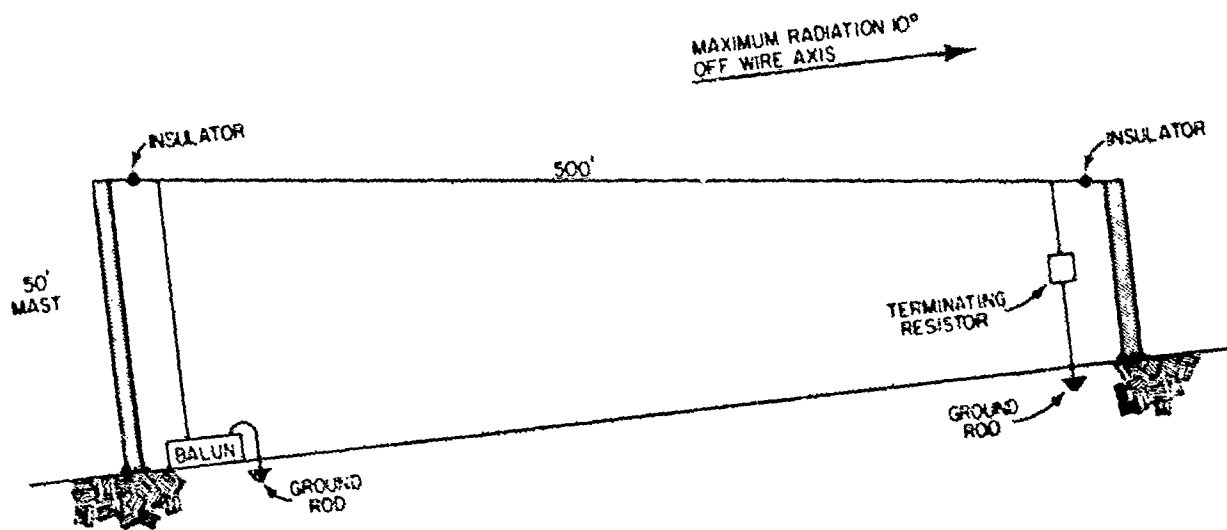

AFWONXX longwire antenna.

VERTICAL HALF RHOMBIC

The vertical half-rhombic antenna is a version of the long-wire antenna that uses a single center support. Easily constructed, this antenna has a small width (as wide as the center support guys) which allows several to be installed in a relatively narrow area. The vertical half-rhombic antenna radiates a medium to low angle signal making it a good choice for medium to long range sky-wave circuits. Normally the 500-foot version is as big an antenna that most tactical situations will allow, however, the vertical radiation pattern for a 1000-foot version is included so that if the opportunity ever exists, the antenna can be used for excellent results.

The vertical half rhombic uses a single wire feed either through a coupler or a balun (12:1). One of the two terminals of the coupler or balun is attached to the antenna while the other terminal is grounded. Like other terminated antennas, the terminating resistor (600 ohms) should be able to handle one half of the transmitter's power output. Terminators can either be procured or locally fabricated (100-watt, 106-ohm resistor, NSN 5905-00-764-5573).

The orientation of this antenna depends on the frequency bands being worked. Below approximately 12 MHz, the terminated end of the antenna is pointed at the distant station; above 12 MHz, the antenna is aimed 10° to either side of the distant station.

Characteristics	
Frequency Range	3 to 30 MHz
Polarization	Vertical
Power Capability	Dependent on terminating resistor
Radiation Pattern	
Azimuthal (Bearing)	Directional
Vertical	
(Take-off angle)	See plots

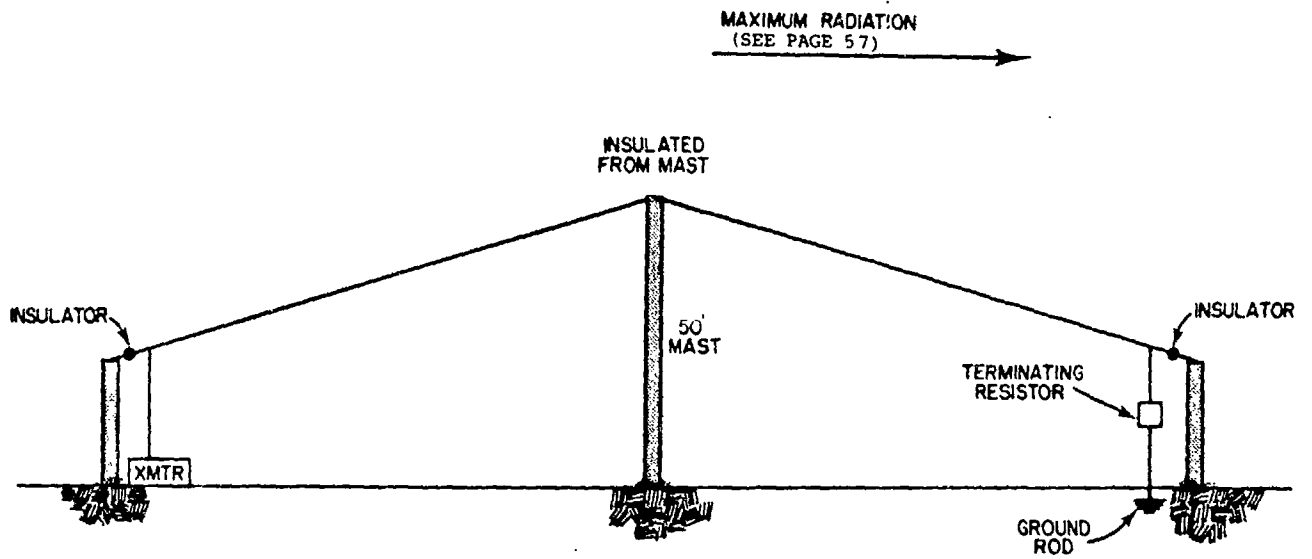

Vertical half-rhombic antenna.

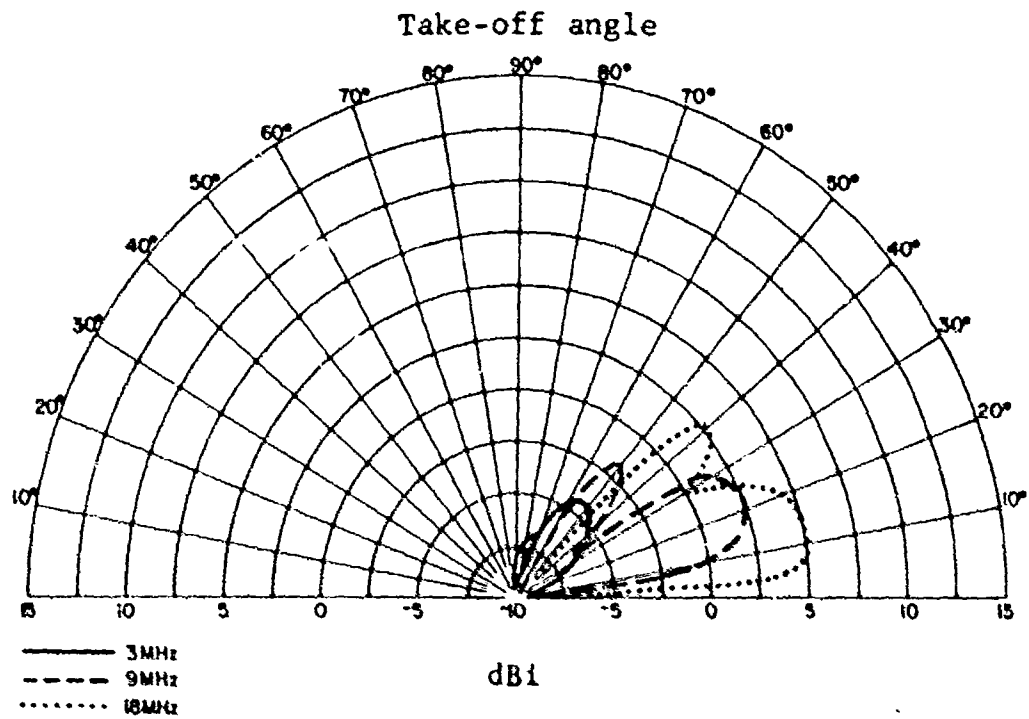

Vertical half-rhombic antenna, vertical pattern,
antenna height 50 feet, length 500 feet.

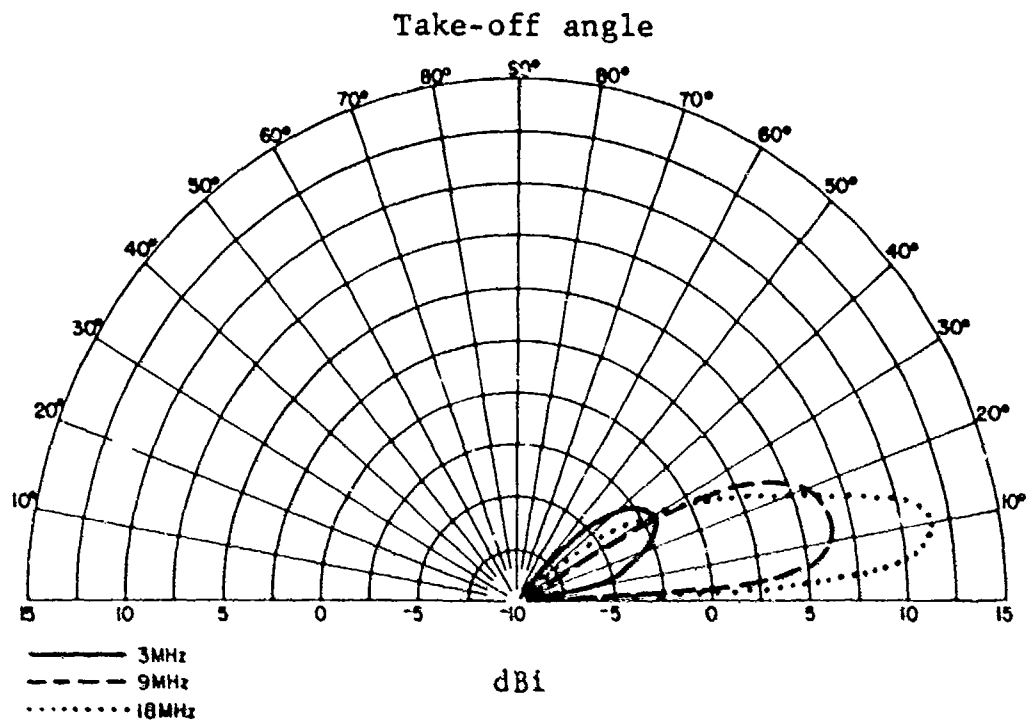

Vertical half-rhombic antenna vertical pattern,
 antenna height 50 feet, length 1000 feet.

SECTION IV VHF ANTENNAS

GENERAL

Selection of VHF antennas is basically a question of the azimuthal radiation pattern of the antenna as all VHF antennas are designed to provide good VHF-LOS radiation. The type of circuit, whether it's a point-to-point circuit or a multipoint circuit, determines the choice of antennas. A directional antenna should be used for the point-to-point circuit in order to direct the maximum amount of radio energy toward the receiving station. On a multipoint circuit, the location of the receiving stations will determine whether an omnidirectional or directional antenna can be used. If the receiving stations are located in all directions from the transmitter, an omnidirectional antenna must be used. If the stations are all located in one general direction from the transmitter, a directional antenna could probably be used. The antenna descriptions included in this section show the azimuthal radiation patterns of the different antennas so that the proper antenna can be selected according to azimuthal coverage.

Siting of VHF antennas has a large effect on communications reliability. In an ideal setting, the antenna would be as high as possible above a flat clear area. In tactical situations, the location of the antenna must be a compromise between propagation considerations and cover and concealment. Even so, antenna sites should be as high as possible and clear of obstructions such as hills, dense woods, and buildings. If it is necessary to site an antenna on or around hills, pick a site that allows line of sight to the distant station or stations. If possible, place the antenna on the military crest of a hill, NOT on the physical crest. Antennas on the physical crest of a hill would provide an "aiming stake" for enemy observation and fire.



WRONG

Ridge line antenna farm.

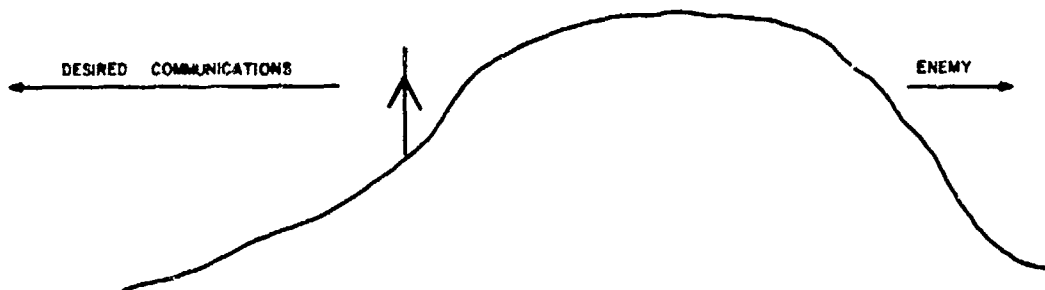

Antenna siting on military crest.

By placing high ground between the antenna and the enemy, not only is the enemy's observation blocked, but radiation from the antenna is blocked, reducing the enemy's intercept capability.

In a dense forest, it is necessary to get the antenna up above the tops of the trees. This height allows the radio signal to propagate in the clear space above the trees. If it is impossible to raise an antenna above the trees, a horizontally polarized antenna will provide better communications through trees than a vertically polarized antenna.

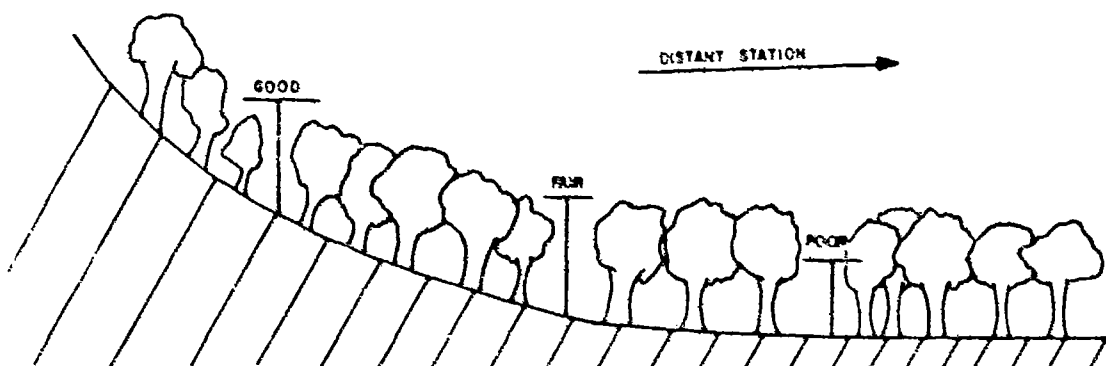

Antenna siting in dense trees.

A clearing in a forest can be used to improve propagation if the antenna can be placed so that the clearing is between the antenna and the distant station (for a directional antenna). An omnidirectional antenna should be placed in the center of a clearing. Again, the antenna should be as high as possible.

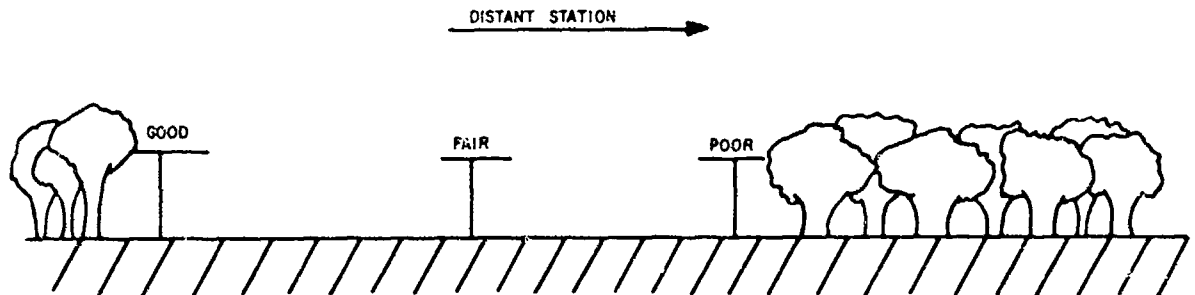

Directional antenna siting in a clearing.

At times it is possible to see the distant station but not communicate with it. In this case the receiving station is suffering destructive multipath interference. This is the combining of the direct and reflected rays out of phase resulting in complete signal cancellation. This interference can also result in a very weak signal or one that "flutters." To improve communications, either raise or lower the antenna or move the antenna around to several different sites. In the majority of cases, one or both of these actions will result in good communications.

Another cause of weak communications is cross-polarization of antennas. This means that the transmit and receive antennas do not have the same polarization. Both antennas should be vertical or horizontal for best communications.

Another problem could be the misalignment of directional antennas. If directional antennas are not correctly pointed at each other, communications will be degraded. The electrical characteristics of directional antennas can change over several field deployments, especially if the antenna is subjected to harsh use. This changing of electrical characteristics can cause the radiation pattern to change so that if the antenna is physically pointed at the distant station, the main radiation may be aimed in another direction. To fix this situation, have the distant station transmit and slowly turn the receiving

directional antenna while listening to the received signal. When the received signal is strongest, the antenna is properly aligned for the circuit. Secure the antenna in this position and have the distant station align its antenna in the same way. When both antennas are properly adjusted, the maximum radiation from each antenna is directed at the other antenna.

The following pages list several "issued" antennas as well as practical field expedient wire antennas. Review of the characteristics and radiation patterns of these antennas should allow the selection of the proper antenna for a specific circuit. A VHF antenna selection matrix is provided to assist the operator in selecting a suitable antenna for the desired VHF circuit.

VHF ANTENNA SELECTION MATRIX

		Directivity			Polarization	
		Omnidirectional	Bidirectional	Directional	Horizontal	Vertical
	Page Number					
Vertical Whip	65	X				X
RC-292	66	X				X
OE-254	68	X				X
AS-2236	70			X	X	X
AS-2851	72			X	X	X
Vertical half-rhombic/OE-303	75		X	X		X

VERTICAL WHIP

The vertical whip is the most commonly used antenna since it is easy and simple to use and it is a part of every radio set. In mobile situations, the vertical whip is the only antenna that can be used. In stationary operations, the vertical whip is not a good choice for two reasons: it cannot be put high in the air for good omnidirectional VHF-LOS communications, and it radiates in useless directions if communications are point to point.

If the tactical situation prevents the use of an antenna other than the vertical whip, several steps can be taken to improve its performance. First, ensure that the antenna is in fact vertical. This can be a problem when using the can-pack short whip or tape in the prone position. Use the flexible base on the tape to ensure that the antenna is in a vertical position.

A reflector can be placed behind a whip to direct radiation in a general direction. A reflector is a vertical wire or another whip placed one-quarter wavelength behind the radiating whip. The reflector is placed at the same height as the whip and is insulated from the ground. The reflector reflects some of the radio energy back towards the whip and provides a broad beam of energy towards the distant station.

Characteristics	
Frequency Range	30 to 88 MHz
Polarization	Vertical
Power Capability	Matched to particular radio
Radiation Pattern	Omnidirectional

RC-292

The RC-292 is a general purpose ground-plane antenna designed to increase the range of tactical VHF radios. The antenna is basically broadband but must be pretuned to one of four frequency ranges for maximum efficiency. It is normally installed at full height (37 to 41.5 feet) on the component mast; however, it may be installed at lower heights if the tactical situation dictates.

The antenna is comprised of a vertical radiating element and three ground-plane elements. These four elements are assembled from a number of antenna sections depending on the frequency band chosen. The supporting mast has a hinged base to allow easy lowering of the antenna to change the number of sections in each element. The chart below lists the number and type of sections to be used in the vertical element and ground plane elements. To provide the best communications, the antenna must be adjusted for the specific band in use.

ANTENNA AND GROUND PLANE SECTIONS

Frequency (MHz)	Vertical Antenna Sections					Ground Plane Sections				
	Number of Sections Required	AB-21/GR	AB-22/GR	AB-23/GR	AB-24/GR	Number of Sections Required Per Element	AB-21/GR	AB-22/GR	AB-23/GR	AB-24/GR
20.0 to 27.9	6	3	1	1	1	6	3	1	1	1
27.9 to 38.9	4	1	1	1	1	5	2	1	1	1
38.9 to 54.4	3	1	1	1	1	4	1	1	1	1
54.4 to 75.95	2	0	1	0	1	3	0	1	1	1

Characteristics

Frequency Range	20 to 75.95 MHz
Polarization	Vertical
Power Capability	45 watts
Radiation Pattern	Omnidirectional
Erection Time	2 persons in 15 minutes
Weight	48 lbs

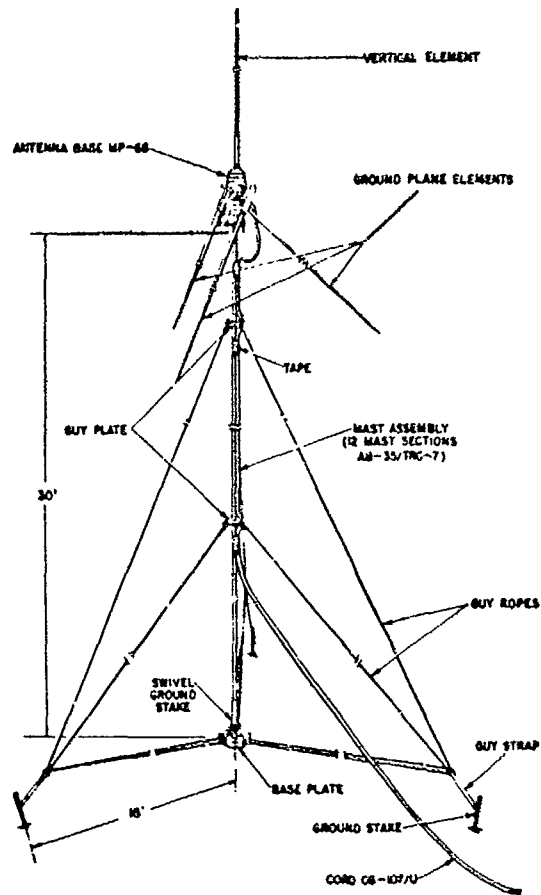

Installed RC-292 antenna.

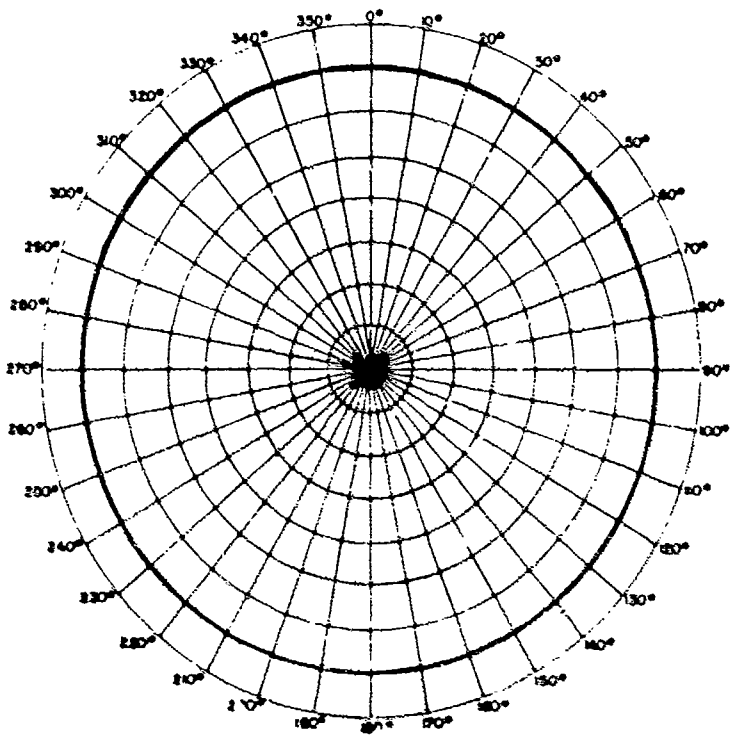

RC-2 antenna azimuthal gain pattern.

OE-254

The OE-254 is a broadband, omnidirectional, biconical antenna that is scheduled to replace the RC-292. Unlike the RC-292, the OE-254 does not require tuning for specific bands and can cover the 30-to-88 MHz VHF band without adjustment.

Three upward and three downward radial elements simulate two cones which provide omnidirectional VHF-LOS radiation. The antenna is usually mounted on a 33-foot 8-inch mast for an overall height of 41 3/4 feet. The antenna may be installed at lower heights; however, care should be taken to ensure that the lower and upper mast adapter assemblies are always used. An 80-foot coaxial cable comes with the antenna for direct connection to a radio.

Characteristics	
Frequency Range	30 to 88 MHz
Polarization	Vertical
Power Capability	350 watts
Radiation Pattern	Omnidirectional
Erection Time	2 persons in 15 minutes
Weight	43.5 lbs

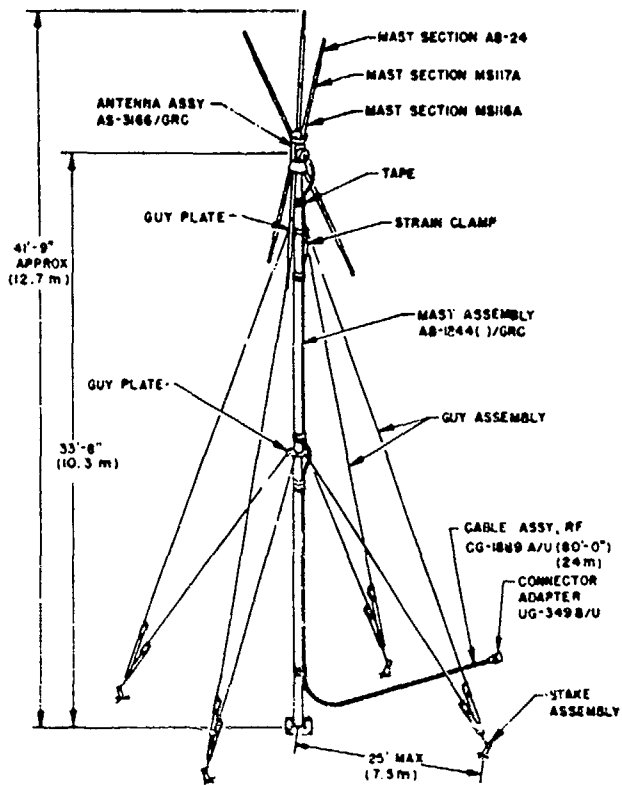

Installed OE-254 antenna.

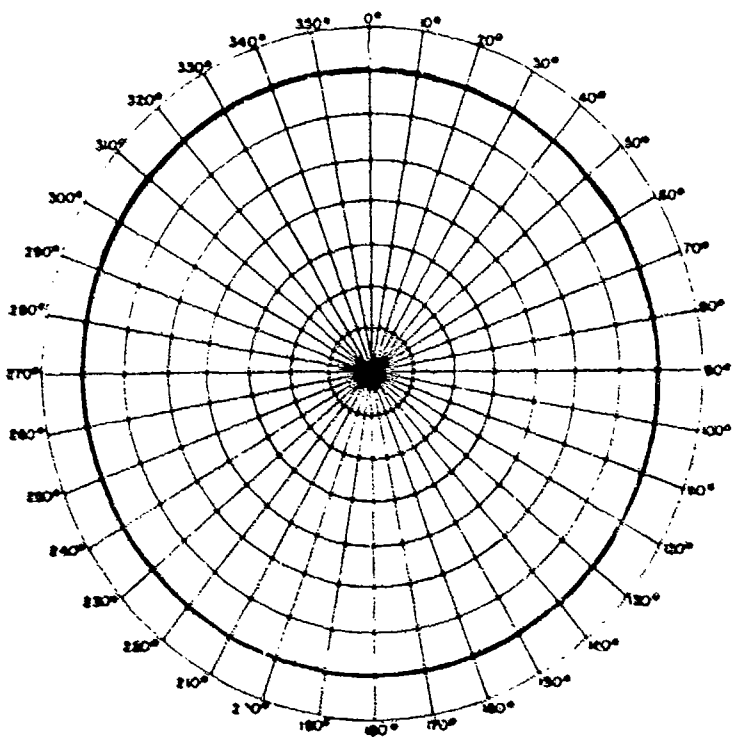

OE-254 antenna azimuthal gain pattern.

AS-2236

The AS-2236 is a broadband log periodic antenna that can be used with either horizontal or vertical polarization. The AS-2236 is used for directional point-to-point circuits.

The antenna uses a triangular base which allows the antenna to be erected on irregular or sloping ground. This base also allows the rotation of the antenna without lowering it. The AS-2236 is aimed by pointing the cloth arrow head on the antenna towards the distant station. Once initial contact is established, the antenna is readjusted as described on page 63.

This antenna comes in three separate packs (antenna pack, tripod pack, mast pack). Because of its relatively heavy weight, it is usually associated with vehicular mounted radios.

Characteristics	
Frequency Range	30 to 75.95 MHz
Polarization	Horizontal or Vertical
Power Capability	65 watts
Radiation Pattern	Directional
Erection Time	2 persons in 30 minutes
Weight	105 lbs

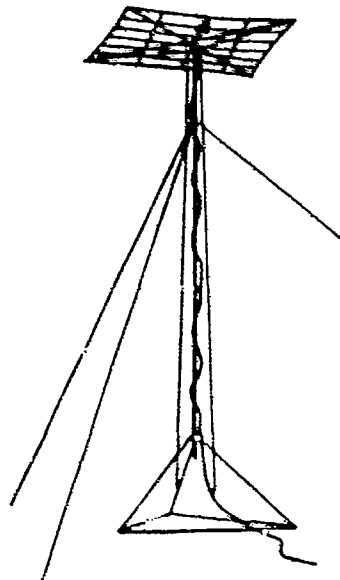

AS-2236 antenna.

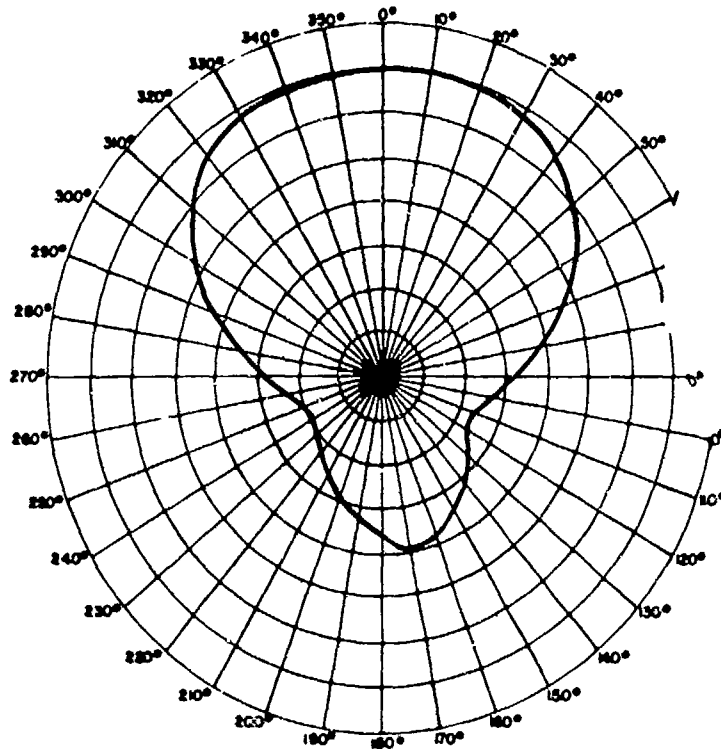

AS-2236 antenna azimuthal gain pattern, 30 MHz.

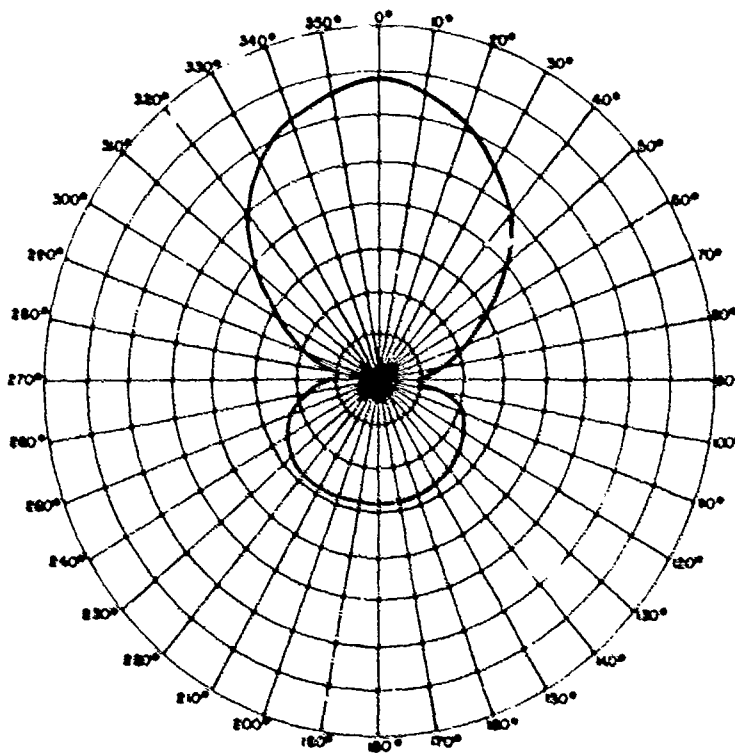

AS-2236 antenna azimuthal gain pattern, 76 MHz.

AS-2851

The AS-2851 is a lightweight log periodic antenna used on directional point-to-point circuits. Supported by a sectioned mast, the antenna can be erected at 2.5-foot increments up to 20 feet. The antenna can be oriented for either vertical or horizontal polarization.

The AS-2851 is initially aligned so that the end of the boom with the shortest elements is pointed towards the distant station. Once initial contact is established, the antenna is adjusted as described on page 63.

Characteristics	
Frequency Range	30 to 75.95 MHz
Polarization	Horizontal or Vertical
Power Capability	65 watts
Radiation Pattern	Directional
Erection Time	2 persons in 10 minutes
Weight	30 lbs

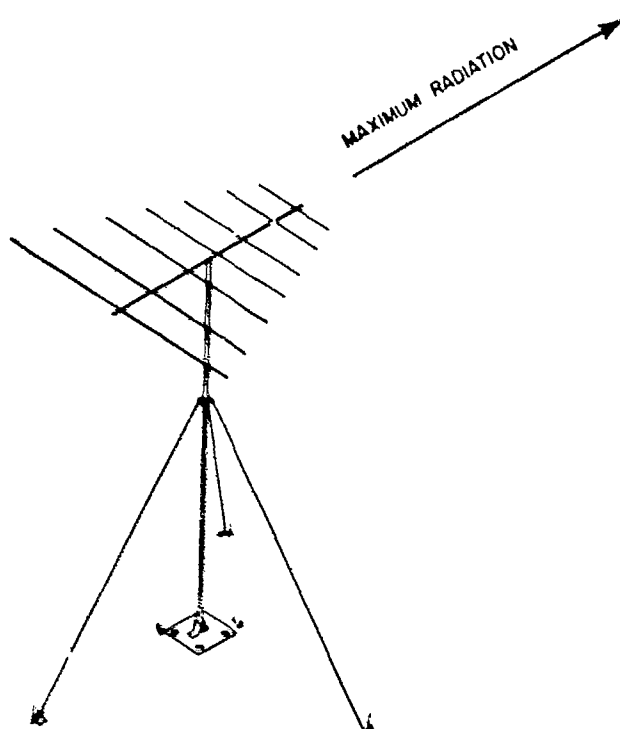

AS-2851 antenna.

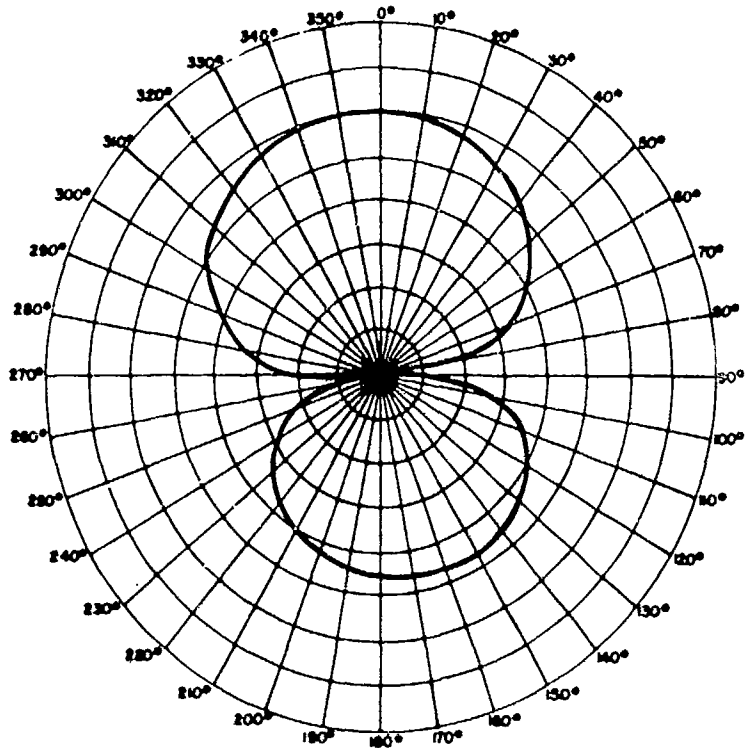

AS-2851 antenna azimuthal gain pattern, 40 MHz, horizontal polarization.

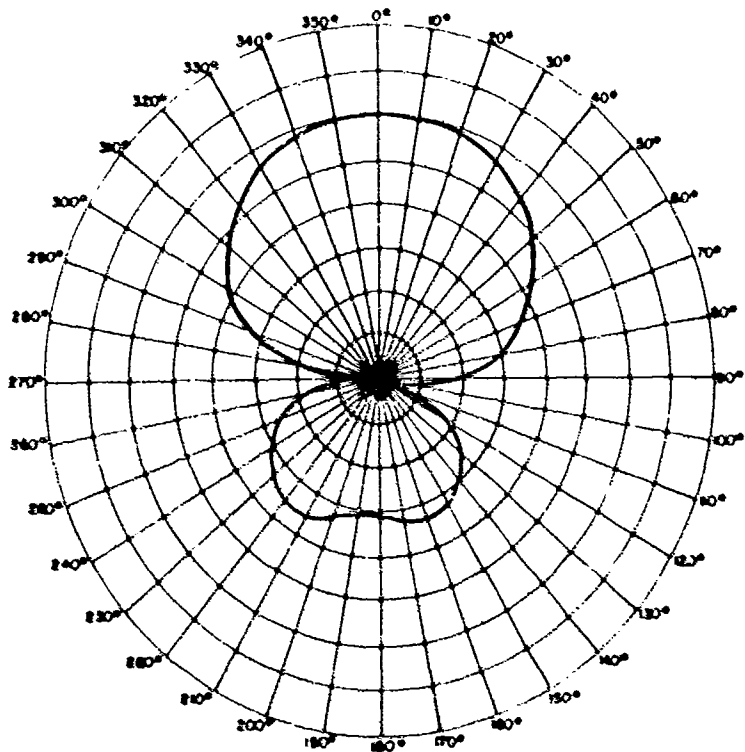

AS-2851 antenna azimuthal gain pattern, 70 MHz, horizontal polarization.

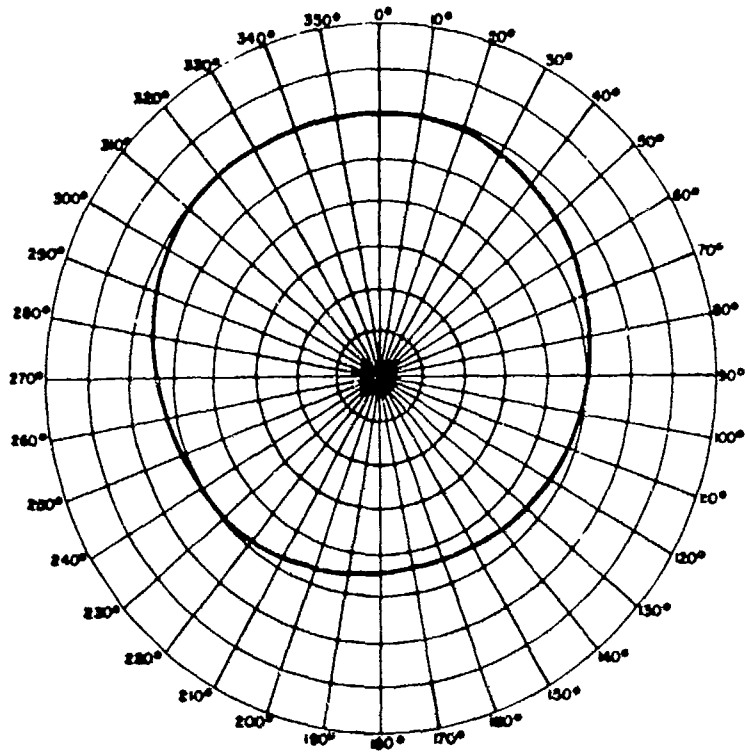

AS-2851 antenna azimuthal gain pattern, 40 MHz, vertical polarization.

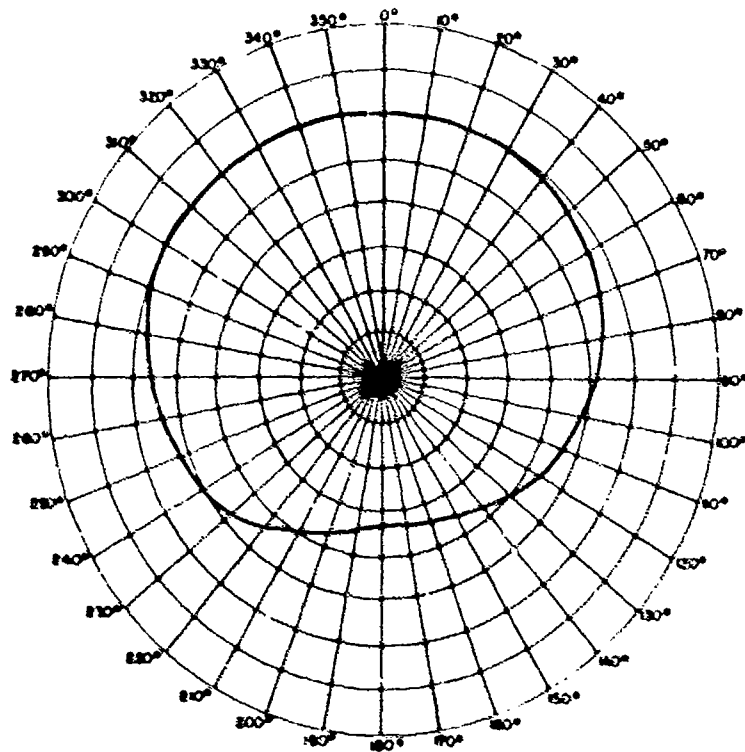

AS-2851 antenna azimuthal gain pattern, 70 MHz, vertical polarization.

VERTICAL HALF RHOMBIC/OE-303

The vertical half-rhombic antenna is an easily constructed wire antenna that provides good directional radiation. The OE-303 is an issued version of a vertical half rhombic. For the most part, comments for the field expedient antenna also hold true for the OE-303.

The typical tactical vertical half-rhombic antenna consists of a 100-foot antenna wire supported in the middle by a 30-foot non-metallic support, and an 85-foot ground wire laid along the ground. In this configuration, the antenna will work well throughout the military VHF band. To make the antenna directional, a 500-ohm carbon terminating resistor is connected between the antenna wire and the ground wire at the distant end of the antenna. A 5-watt carbon resistor, which is suitable for man-pack radios, is commercially available from radio parts stores. For higher power radios, multiple 5-watt resistors can be connected in parallel to obtain the proper wattage and resistance. Without the terminating resistor, the antenna is bidirectional.

The antenna wire is connected directly to the antenna terminal on the radio. On man-pack radios, the whip base can be screwed in to the antenna terminal to securely clamp the antenna wire to the radio. The ground wire should be connected to a convenient point on the radio case.

The vertical half-rhombic antenna should be oriented so that the wire ends point in the desired direction of propagation. In the bidirectional antenna (no terminating resistor), communications can be accomplished off both ends of the wire. In the terminated (directional) version, communications can be established off the end of the wire with the terminating resistor.

Characteristics	
Frequency Range	30 to 88 MHz
Polarization	Vertical
Power Capability	Dependent on terminating resistor
Radiation Pattern	Bidirectional Directional with terminating resistor

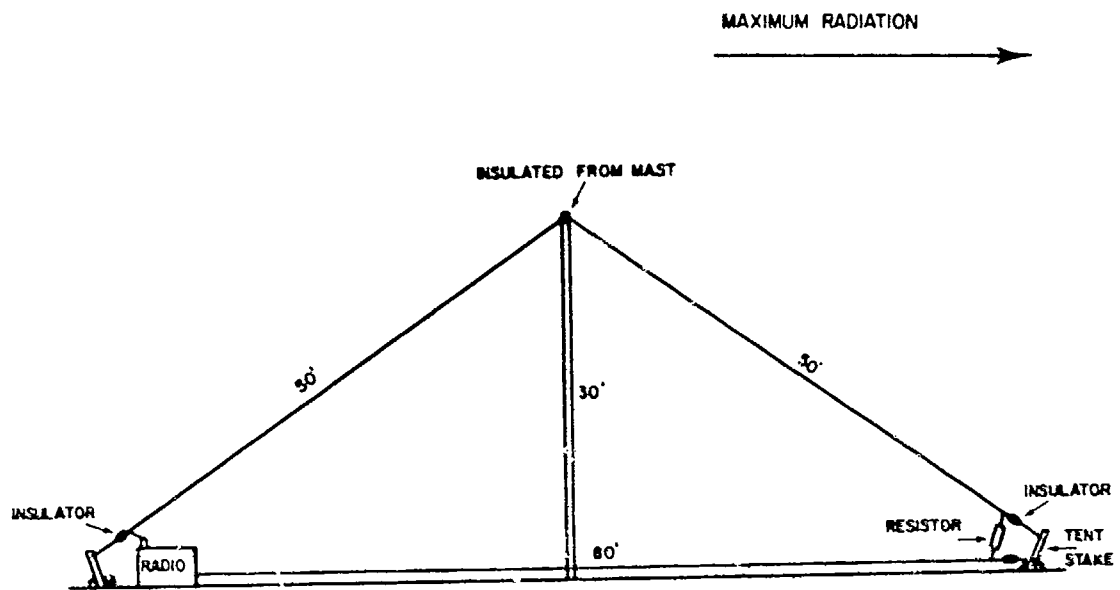

Military vertical half rhombic.

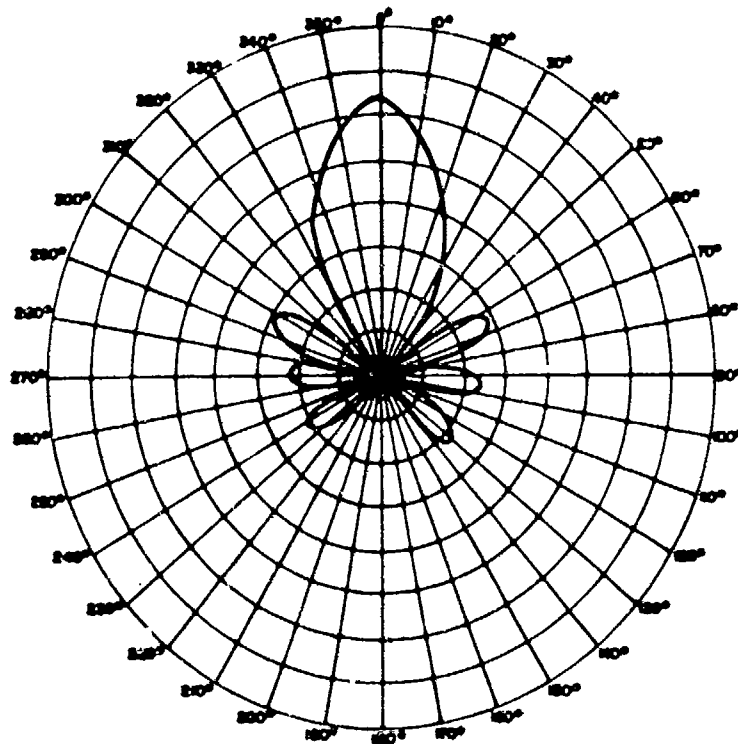

Vertical half-rhombic antenna, azimuthal gain pattern, 30 MHz.

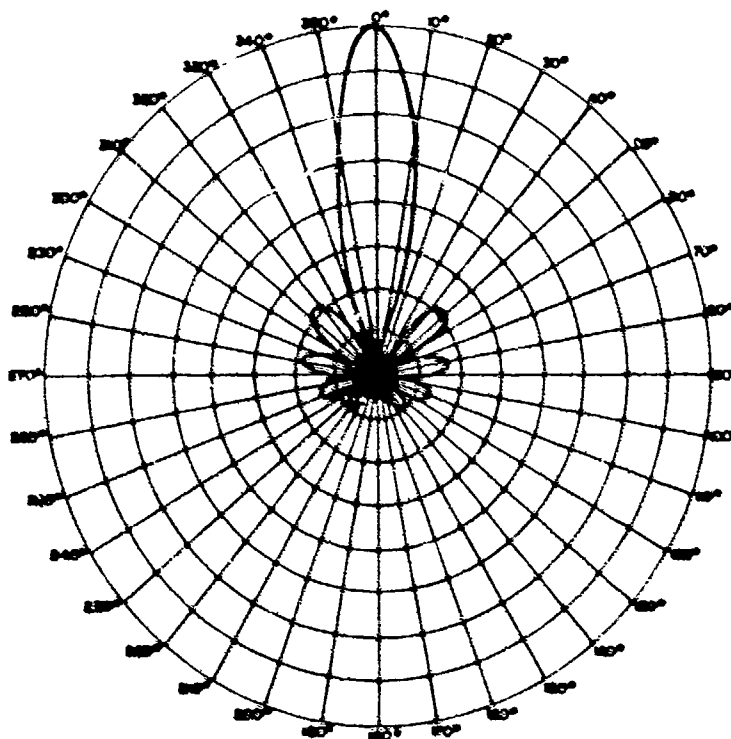

Vertical half-rhombic antenna, azimuthal gain pattern, 70 MHz.

SECTION V
EXPEDIENT TECHNIQUES

Using an issued antenna or constructing a field expedient antenna is easy if you have all the required parts. What happens when you're in a field situation, your antenna is broken, and you have to make do with what you have? Obviously communications must be maintained. It is up to the radio operator to make some type of antenna to provide communications for his unit.

REPAIR OF BROKEN ANTENNAS

A broken whip can be temporarily repaired in several ways. If the whip is broken in two sections, the sections can be joined together. First remove the paint and clean the sections where they will join to ensure a good electrical connection. Place the sections together and secure with bare wire or tape.

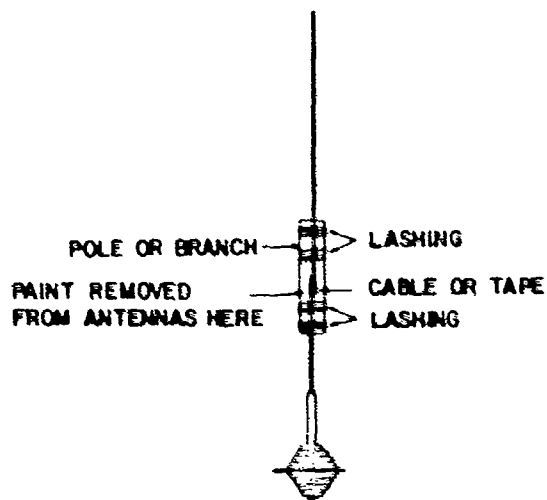

Using broken sections for emergency repair.

If the whip is badly damaged, a length of field wire (WDI/TT) of the same length as the original antenna can be used. Remove the insulation from the lower end of the field wire antenna, twist the conductors together, stick them in the antenna base connector and secure with a wooden block. Either a pole or a tree can be used to support the antenna wire.

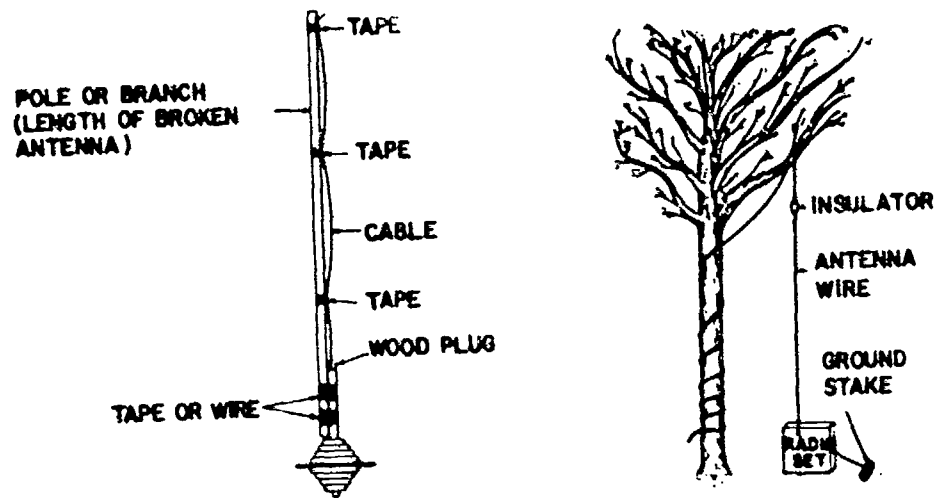

Using field wire as an emergency whip.

INSULATORS

Insulators can be made from many items that are readily available. Care should be taken with any material that holds water (cloth, rope). In a rainstorm, these items absorb water and lose their insulating characteristics.

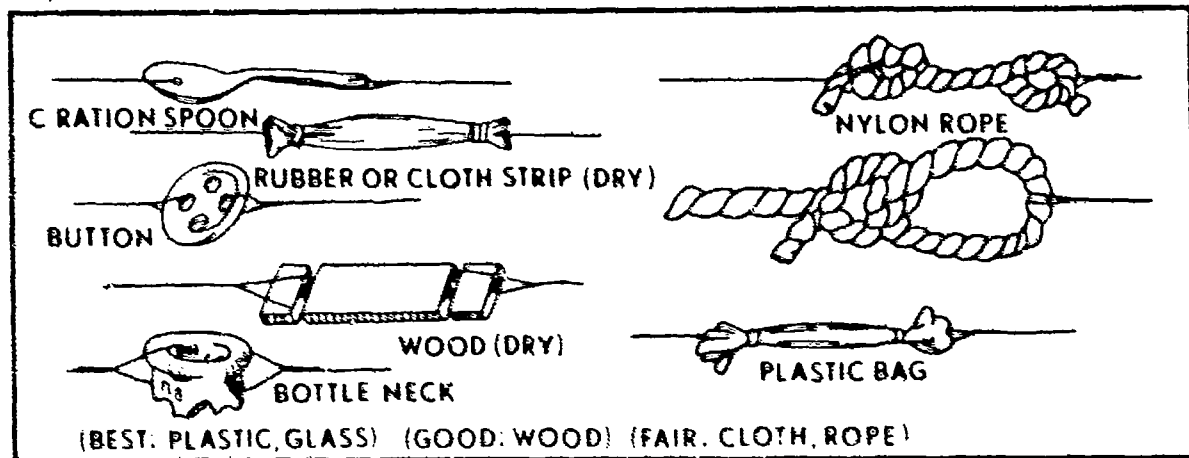

Expedient insulators.

SUPPORTS

Many expedient antennas require supports to hold the antenna above ground. The most common supports are trees which have the advantage of being able to survive heavy wind storms. However,

even the largest trees sway in the wind, enough to break wire antennas. To keep the antenna taut and to prevent it from breaking or stretching as the trees sway, a spring or piece of old inner tube should be attached to one end of the antenna. If a small pulley is available, attach the pulley to the tree, pass a rope through the pulley, attach the rope to the end of the antenna, and load the other end of the rope with a heavy weight. This will allow the tree to sway without straining the antenna.

The AN/GRA-4 Antenna Group should not be overlooked when constructing field expedient antennas. The technical manual shows how the antenna group can be used as a 40-foot vertical monopole, sloping wire, and half-wave dipole, but other antennas can be made using this group's components. Using the 40-foot mast with the base insulator a 40-foot high inverted L can be constructed using the mast as the vertical element. The two 40-foot masts that come with the antenna group can be used to support any of the antennas discussed in this handbook.

At times the radio operator will find himself at a site where no trees or issued antenna masts are available to support an antenna. In this situation the operator must survey what is available and try to jury rig some type of support. If lance poles or PO-2 poles are available, they can be lashed together to form a support. In areas that are not windy, helium-filled weather balloons can be used to support antennas. The lower, thick portions of a 32-foot whip can also be used as supports. If vans are being used with a roof-mounted 32-foot antenna, the lower thick portion of the antenna can be used (with the thin top portion removed) as the vertical part of an inverted L antenna. Wire is attached to the end of the remaining whip to form the horizontal portion of the antenna. The operator must use imagination and ingenuity to devise some type of support to provide reliable communications.

TERMINATING RESISTORS

Terminating resistors have been a continual problem for the field communicator. Several high power van type radio systems have terminating resistors as components, however, those resistors are not always available. Resistors for low power (man pack) VHF radios are readily available from commercial radio supply stores. Carbon resistors capable of dissipating more than 5 watts are difficult to find. However the 5-watt resistors can be connected in parallel to make a terminator capable of handling higher powers. For example, eight 5-watt 4000-ohm resistors connected in parallel results in a 500-ohm 40-watt terminator.

The 5-watt resistor still does not solve the problem of high power HF terminators. A terminator for a 1000-watt transmitter would require 100 5-watt resistors! A 100-watt 106-ohm resistor exists in the supply system (NSN 5905-00-764-5573) that can be mounted in series on a single insulating board to form a terminator for high powered transmitters.

EXPEDIENT WIRE

Field telephone wire (WD1/TT) can be used to construct antennas if regular antenna wire is not available. Field wire consists of two insulated wires loosely twisted together. Each insulated wire is made up of four copper strands and three steel strands of wire. When making electrical connections with field wire, the copper strands should be used. The four copper strands can be identified by removing approximately one inch of insulation from one end of the insulated wire. Hold the wire where the insulation ends and bend the strands to the side. When bending pressure is released the steel strands will snap back to their original position while the copper strands will remain bent. These copper strands can then be wrapped around the steel strands to present a copper surface for a good electrical connection.

If field wire is to be used as the radiating element of an antenna, the two insulated wires in the twisted pair must be connected together at the ends so that electrically the two wires will act as one. First tightly twist all six steel strands from the two wires together (for strength), twist the eight copper strands together (for electrical connection) and then twist the copper strands around the steel strands.

When used as a feed line for a dipole antenna, connect each of the two insulated wires of the twisted pair to a separate leg of the dipole. At the radio, connect one wire (it does not matter which wire) to the center connector of the radio antenna terminal and the second wire to a screw on the antenna case.

Feeding a VHF-LOS ground plane antenna with field wire requires a slightly different procedure. In this case the wire connected to the vertical element must be connected to the center connector of the radio antenna terminal. If a multimeter is available, it is easy to perform a continuity test to determine which wire of the twisted pair should be connected to the vertical element. Without a multimeter there are two ways to test the wires. The first is to start at one end and follow the single wire through the twists until you reach the other end. An

easier way is to connect one wire to the center connector of the radio antenna terminal and then individually touch the bare wires from the other end of the field wire to the radio case. The radio should be turned on, squelch off, volume control to maximum loudness. One of the two wires will produce a loud pop or click in the speaker when touched to the case. This wire is the other end of the wire connected to the center connector and which will be connected to the vertical element of the ground plane antenna. The other wire of the twisted pair will be connected to the ground plane section of the antenna and to the case of the radio.

In an emergency, any wire of sufficient length can be used for an antenna. Barbed wire, electrical wire, fence wire, and metal cored clothesline are some examples. The important thing to remember is not to give up. Communications have been successful using metal house gutters and even metal bed springs! A radio operator's mission is not accomplished until communications are established.

GROUNDING

A good electrical ground is needed for two reasons: first, as a safety ground to protect the operator and his equipment, and second, as an RF ground needed by some antennas to function properly. Most radio sets come with a ground rod that should provide a sufficient ground if used properly in good soil. Used properly means the ground rod is free from oil or corrosion and is driven into the ground so that the top of the rod is below surface. To ensure a good electrical connection, the top of the ground rod and the end of the ground strap should be clean and bright. A clamp or nut and bolt should be used to make a good mechanical and electrical connection at the ground rod. The end of the ground strap and the radio ground connection should both be cleaned before connection is made.

If a ground rod is not available, water pipe, concrete reinforcing rod, metal fence post (protective paint coating must be removed), or any length of metal can be used. If a water system uses metal pipe, a good ground can be established by clamping the ground strap to a water pipe. Underground pipes, tanks, and metal building foundations will also work. **WARNING: NEVER USE ANY PIPING OR UNDERGROUND TANKS THAT CONTAIN FLAMMABLE MATERIALS (NATURAL GAS, GASOLINE, ETC.)!!**

In dry soil, electrical grounds can be improved by adding water and chemicals to the soil. Two common chemicals are Epsom

Salts and common table salt. Epsom salts are preferred because it is not as corrosive as table salt. Make a solution of five pounds of chemical to five gallons of water and slowly pour the solution in a hole dug around the ground rod. Water should be added periodically to keep the area damp. If water is not available, urine can be used.

Multiple ground rods can also be used to improve electrical grounds. If enough rods are available, a "star ground" can be built. A single rod is driven in the center of an approximately 20-foot circle. Along the outside of the circle, additional ground rods are driven. The ground strap from the radio is connected to the center ground rod which in turn is connected to the rods along the outside of the circle. The rods on the outside of the circle should also be connected together.

SECTION VI

FOR MORE INFORMATION

For those who desire more details on propagation and antennas, the following listing is provided.

Army

FM 11-65 High Frequency Radio Communications
FM 24-18 Field Radio Techniques
TM 11-666 Antennas and Radio Propagation

Construction of Field Expedient Antennas, CRC-504,
Communications/Electronics Department, USAFAS, Ft. Sill, OK.

Conventional and Field Expedient Antennas, Manual 4501,
Signal Center, Ft. Gordon GA

Tactical Antenna Systems, Information Sheet 1167, Signal
Center, Ft. Gordon, GA.

Air Force

AFCSP 100-16 High Frequency Radio Communications in a
Tactical Environment

AFCSP 100-47 Tactical High Frequency Antenna Handbook

Common HF Antenna Vertical Radiation Patterns, 8009-311,
Interservice Radio Frequency Management School, Keesler AFB, MS.

Antenna Theory and Practical Application, 7801-301,
Interservice Radio Frequency Management School, Keesler AFB, MS.

Frequency Management Digest Anthology, Vol. I and II,
Spectrum Management Division, Air Force Communications Command,
Scott AFB, IL.

Antennas--General, Tactical HF Antenna Kit, AFCC-CEMI
1300-1, Air Force Communications Command, Scott AFB, IL

Marine Corps

Antennas, Conventional and Field Expedient, SM COS 5,
Communication Officers School, MCDEC, Quantico, VA.